

Contents

Safety Information	4
Technical Support	5
Conventions Used in This Guide	5
Packing List	6
Revision History	7
Specifications Summary	8
Block Diagram	11
Production Introduction	13
1.1 Before you Proceed	13
1.2 Motherboard Overview	14
1.2.1 Placement Direction	14
1.2.2 Screw Holes	14
1.3 Motherboard Layout	15
1.3.1 Layout Content List	16
1.4 Central Processing Unit (CPU)	18
1.4.1 Installing the CPU	19
1.4.2 Installing the CPU Heatsink and Fan	21
1.4.3 Uninstalling the CPU Heatsink and Fan	23
1.5 System Memory	24
1.5.1 SO-DIMM Sockets Location	24
1.5.2 Memory Configurations	25
1.5.3 Installing a DDR2 SO-DIMM	26
1.5.4 Removing a DDR2 SO-DIMM	27
1.6 Expansion Slots	28
1.6.1 Installing an Expansion Card	28
1.6.2 Configuring an Expansion Card	28
1.6.3 Standard Interrupt Assignments	29
1.6.4 PCI Slots	30
1.6.5 PCI Express x1 Slots	30
1.6.6 Mini PCI Express Slots	30
1.7 Jumpers	31
1.7.1 Clear CMOS (CCMOS1)	31
1.7.2 COM1 RI/+5V/+12V Selection (JCOMPWR3)	32
1.7.3 COM2 RI/+5V/+12V Selection (JCOMPWR2)	32
1.8 Connectors	33
1.8.1 Rear Panel Connectors	33

Contents

1.8.2	Amplifier Connector (AMPJ1).....	35
1.8.3	Serial Port 2-3 Connector (COM2, COM3)	36
1.8.4	Serial Port 4-5 Connector (COM4, COM5)	36
1.8.5	CPU Fan Connector (CPU_FAN1).....	37
1.8.6	System Fan Connector (SYS_FAN1).....	37
1.8.7	System Panel Connector (FPIO1).....	38
1.8.8	Digital I/O Connector	39
1.8.9	LVDS Connector (JLVDS1)	39
1.8.10	LCD Inverter Connector (JBKL1).....	40
1.8.11	SPI Connector (JSPI1).....	41
1.8.12	Digital Audio Connector (SPDIF_OUT1)	41
1.8.13	Serial SATA Connector (SATA1, SATA2, SATA3, SATA4)	42
1.8.14	SATA Power Connector (SATA_POWER1, SATA_POWER2).....	43
1.8.15	USB 2.0 Connector (USB1, USB2).....	43
BIOS Setup		44
2.1	Managing and updating your BIOS	45
2.2	BIOS setup program	46
2.3	Main Setup.....	48
2.4	Advanced BIOS Setup.....	49
2.4.1	Super I/O Configuration.....	55
2.4.2	ACPI Configuration.....	60
2.4.3	AHCI Configuration	63
2.4.4	APM Configuration	65
2.4.5	Intel AMT Configuration.....	66
2.4.6	Intel TXT(LT) Configuration.....	67
2.4.7	Intel VT-d Configuration	68
2.4.8	Trusted Computing.....	69
2.5	Advanced PCI/PnP Settings	70
2.6	Boot Setting Configuration	73
2.7	Security Setup.....	76
2.8	Chipset Setup.....	77
2.8.1	North Bridge Configuration.....	78
2.8.2	South Bridge Configuration	80
2.9	Exit Menu	83

Safety Information

Electrical safety

- To prevent electrical shock hazard, disconnect the power cable from the electrical outlet before relocating the system.
- When adding or removing devices to or from the system, ensure that the power cables for the devices are unplugged before the signal cables are connected. If possible, disconnect all power cables from the existing system before you add a device.
- Before connecting or removing signal cables from the motherboard, ensure that all power cables are unplugged.
- Seek professional assistance before using an adapter or extension cord. These devices could interrupt the grounding circuit.
- Make sure that your power supply is set to the correct voltage in your area. If you are not sure about the voltage of the electrical outlet you are using, contact your local power company.
- If the power supply is broken, do not try to fix it by yourself. Contact a qualified service technician or your retailer.

Operation safety

- Before installing the motherboard and adding devices on it, carefully read all the manuals that came with the package.
- Before using the product, make sure all cables are correctly connected and the power cables are not damaged. If you detect any damage, contact your dealer immediately.
- To avoid short circuits, keep paper clips, screws, and staples away from connectors, slots, sockets and circuitry.
- Avoid dust, humidity, and temperature extremes. Do not place the product in any area where it may become wet.
- Place the product on a stable surface.
- If you encounter technical problems with the product, contact a qualified service technician or your retailer.



The symbol of the crossed out wheeled bin indicates that the product (electrical and electronic equipment) should not be placed in municipal waste. Check local regulations for disposal of electronic products.

Technical Support

If a problem arises with your system and no solution can be obtained from the user's manual, please contact your place of purchase or local distributor. Alternatively, please try the following help resources for further guidance. Visit the Advansus website for FAQ, technical guide, BIOS updates, driver updates, and other information:

<http://www.advansus.com.tw>

Conventions Used in This Guide

To make sure that you perform certain tasks properly, take note of the following symbols used throughout this manual.



DANGER/WARNING: Information to prevent injury to yourself when trying to complete a task.



CAUTION: Information to prevent damage to the components when trying to complete a task.



IMPORTANT: Instructions that you **MUST** follow to complete a task.



NOTE: Tips and additional information to help you complete a task.

Packing List

Before you begin installing your single board, please make sure that the following materials have been shipped:

- ✓ 1 x Intel 80I-GM4502-M0000B2 IX45GM2 Mini-ITX Motherboard
- ✓ 1 x CD-ROM contains the followings:
 - User's manual (this manual in PDF file)
 - Drivers
- ✓ 1 x 14GS000073V04 COM1+2 cable (9-pin w/o bracket, 30cm, 1.0mm pitch)
- ✓ 2 x 14G000100915 SATA CABLE KIT(SATA/POWER)
- ✓ 1 x I/O Shield
- ✓ 6 x 4# Screws
- ✓ 1 x Startup Manual



If any of the above items is damaged or missing, please contact your retailer.

Revision History

Revision	Revision History	Date
V 1.0	First release for PCB 1.00	November 2, 2009



Specifications Summary

Specifications

System	
CPU	Supports Intel socket P Core 2 Duo / Core Duo / Core 2 Solo / Core Solo mobile CPU with 45nm process technology
FSB	667/800/1066 MHz
BIOS	AMI 32Mb SPI BIOS
System Chipset	Intel GM45/ICH9M-E
I/O Chipset	Winbond W83627DHG-A
Memory	2 x 200-pin SODIMM socket supports up to 4 GB Dual channel DDR2 533/667 SDRAM
CompactFlash	One CompactFlash Type I/II socket (optional)
Watchdog Timer	Reset: 1 sec.~255 min. and 1 sec. or 1 min./step
H/W Status Monitor	Monitoring CPU temperature, voltage, and cooling fan status. Auto throttling control when CPU overheats
Expansion Slots	1 x PCI slot (PCI Rev.2.2 compliant) supports 3 PCI master 1x PCI-E x1 Slot
S3	S3 Support
SmartFan Control	Yes
I/O	
MIO	4 x SATA, 8 x USB, 5 x RS-232, 1 x K/B & Mouse (COM1~2 with power output)
USB	8 x USB 2.0 ports
DIO	8-bit General Purpose I/O for DI and DO
Display	
Chipset	Intel Graphics Media Accelerator 4500MHD
Display Memory	Intel DVMT 5.0 supports 384 MB video memory
Resolution	2048 x 1536 @ 32 bpp(@ 60Hz)
Dual Display	CRT + LVDS, or CRT + DVI-D
LVDS	Dual-channel 24-bit LVDS
DVI	TI SN75DP139 DisplayPort to TMDS transmitter
HDMI	AsMedia 1442T HDMI/DVI Level Shifter
Audio	
Audio Codec	Realtek ALC888 Audio Codec 5.1+2 CH. with two independent audio stream
Audio Interface	Mic in, Line in, Line out
Audio Amplifier	TPA3005D2 Stereo 5Watt per channel

Ethernet	
LAN1	Intel 82567LM Gigabit Ethernet Controller
LAN2	Intel 82574L PCI-E Gigabit Ethernet Controller (optional)

Mechanical & Environmental	
Power Type	ATX
Operating Temperature	0~60°C (32~140°F)
Operating Humidity	0%~90% relative humidity, non-condensing
Size (L x W)	6.69" x 6.69" (170 mm x 170 mm)
Weight	0.88 lbs (0.4 Kg)

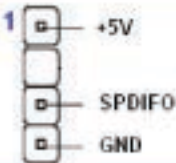
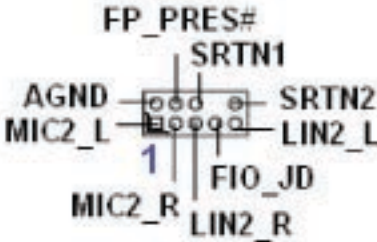
Jumpers			
Label	Function	Note	
CLRTC1	Clear CMOS	Normal *	Clear CMOS
			
SPDIF_OUT1			
AAFP1	Front Panel Audio Connector		

Connectors		
Label	Function	Note
EATXPWR1	ATX Power Connector	

Block Diagram

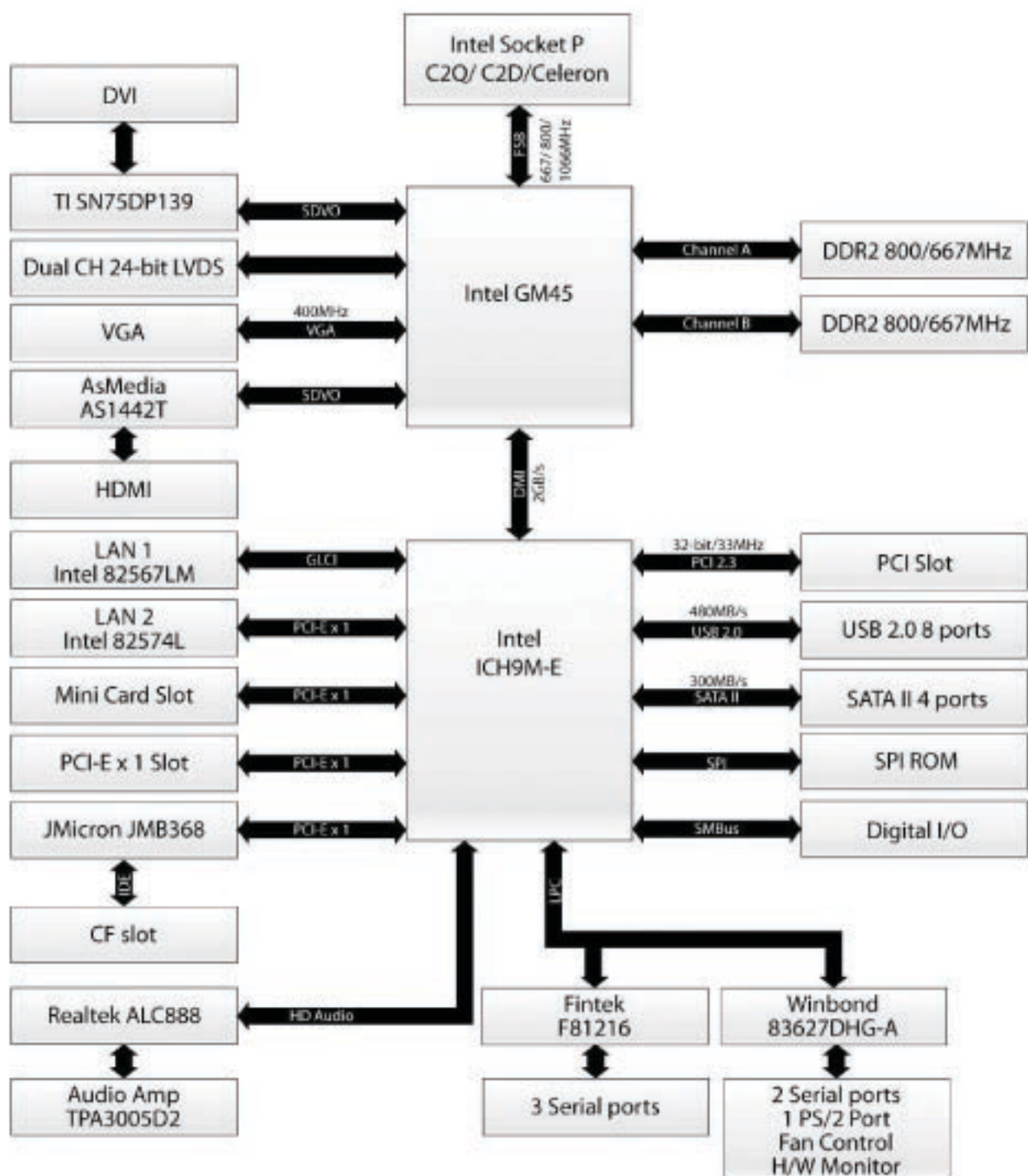

This chapter describes the motherboard features and the new technologies it supports.

1 Product introduction

Production Introduction

1.1 Before you Proceed

Take note of the following precautions before you install motherboard components or change any motherboard settings.



-
- Unplug the power cord from the wall socket before touching any component.
 - Use a grounded wrist strap or touch a safely grounded object or a metal object, such as the power supply case, before handling components to avoid damaging them due to static electricity.
 - Hold components by the edges to avoid touching the ICs on them.
 - Whenever you uninstall any component, place it on a grounded antistatic pad or in the bag that came with the component.
 - Before you install or remove any component, ensure that the ATX power supply is switched off or the power cord is detached from the power supply. Failure to do so may cause severe damage to the motherboard, peripherals, and/or components.
-

1.2 Motherboard Overview

Before you install the motherboard, study the configuration of your chassis to ensure that the motherboard fits into it. Refer to the chassis documentation before installing the motherboard.



Make sure to unplug the power cord before installing or removing the motherboard. Failure to do so can cause you physical injury and damage motherboard components.

1.2.1 Placement Direction

When installing the motherboard, make sure that you place it into the chassis in the correct orientation. The edge with external ports goes to the rear part of the chassis as indicated in the image below.

1.2.2 Screw Holes

Place four (4) screws into the holes indicated by circles to secure the motherboard to the chassis.



Do not over tighten the screws! Doing so can damage the motherboard.

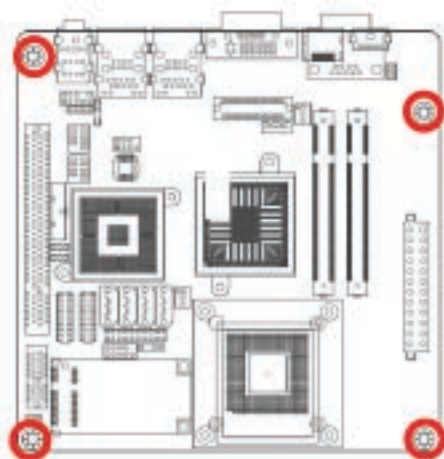

Place this side towards the rear of the chassis

1.3 Motherboard Layout*

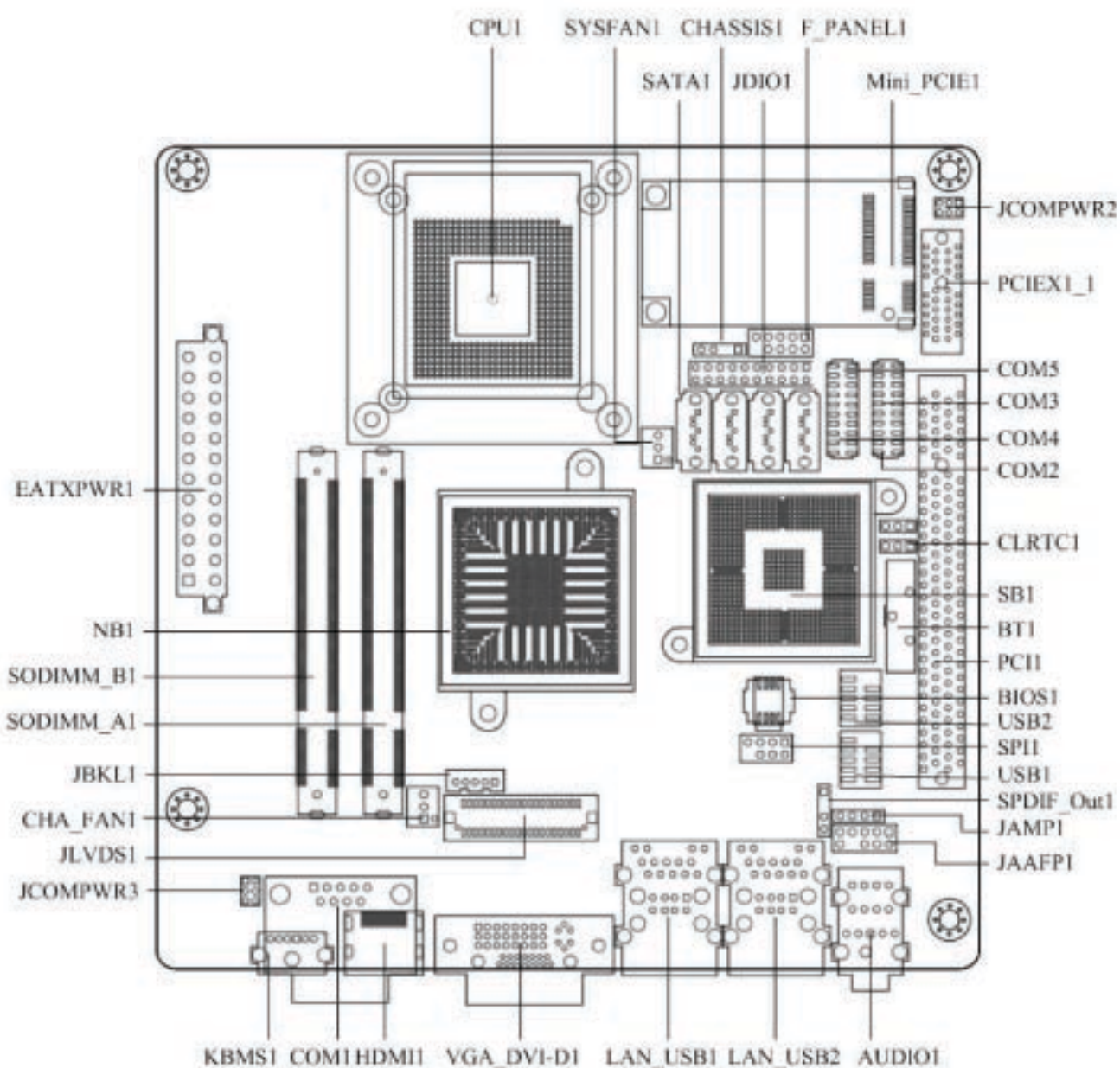

1.3.1 Layout Content List

Slots

Label	Function	Note	Page
CF1A	Compact Flash connector	(Rear side)	N/A
SODIMM_A1	200-pin SODIMM slot 1		24
SODIMM_B1	200-pin SODIMM slot 2		24
PCIEX1_1	PCI Express x1 Slot		30
MINI_PCIE1	Mini PCI Express slot		30
PCI1	PCI slot		30

Jumpers

Label	Function	Note	Page
CLRTC1	Clear CMOS	3 x 1 header, pitch 2.54mm	31
JCOMPWR3	COM 1 RI/+5V/+12V selection	3 x 2 header, pitch 2.00mm	32
JCOMPWR2	COM 2 RI/+5V/+12V selection	3 x 2 header, pitch 2.00mm	32
CHASSIS1	Chassis intrusion	4 x 1 header, pitch 2.54mm	32

Rear Panel Connector

Label	Function	Note	Page
KBMS1	PS/2 keyboard and mouse	6-pin Mini-Din	33
COM1	Serial port connector	D-sub 9-pin, male	33
VGA_DVI-D1	VGA connector DVI connector	D-sub 15-pin, female	33,34
HDMI1	HDMI connector	HDMI 19-pin	
LAN_USB1	RJ-45 Ethernet connector x 1 USB connector x 2		33,34
LAN_USB2	RJ-45 Ethernet connector x 1 USB connector x 2		33,34
AUDIO1	Line-in port, Line-out port, Microphone port,	5.1 Channel Audio I/O (3 jacks)	34

Internal Connector

Label	Function	Note	Page
JAMP1	Amplifier connector	4 x 1 header, pitch 2.54mm	35
EATXPWR1	ATX power connector	12 x 2 header	35
COM23	Serial port 2 & 3 connector	10 x 2 header, pitch 2.00mm	36
COM45	Serial port 4 & 5 connector	10 x 2 header, pitch 2.00mm	36
CPU_FAN1	CPU fan connector	3 x 1 wafer, pitch 2.54mm	37
SYS_FAN1	System fan connector	3 x 1 wafer, pitch 2.54mm	37
FPIO1	System panel connector	5 x 2 header, pitch 2.54mm	38
JDIO1	Digital I/O connector	10 x 2 header, pitch 2.00m	39
JLVDS1	LVDS connector	HIROSE DF13S-40DP-1.25V	39
JBKL1	LCD Inverter connector	5 x 1 header, pitch 2.00mm	40
JSPI1	SPI connector	4 x 2 header, pitch 2.54mm	41
SPDIF_OUT1	Digital Audio connector	4 x 1 header, pitch 2.54mm	41
SATA1,2,3,4	Serial ATA connectors 1,2,3,4	7-pin header	42
SATA_POWER1 SATA_POWER2	SATA Power connectors 1,2	4-pin header	43
USB1,2	USB 2.0 connector	5 x 2 header, pitch 2.54mm	43

1.4 Central Processing Unit (CPU)

The motherboard comes with a surface mount 478-pin designed for the Intel® socket 479P Core Duo / Core Solo / Core 2 Duo CPU with 65nm process.

Take one of the marked corner (with gold triangle) on the CPU. This mark should match a specific corner on the socket to ensure correct installation.



-
- Make sure the AC power is off before you install the CPU.
 - If installing a dual-core CPU, connect the CPU fan cable to the **CPU_FAN1** connector to ensure system stability.
-



-
- Your boxed Intel® socket 479P Core Duo / Core Solo / Core 2 Duo CPU with 45nm process package should come with installation instructions for the CPU, heatsink, and the retention mechanism. If the instructions in this section do not match the CPU documentation, follow the latter.
 - Upon purchase of the motherboard, make sure that the PnP cap is on the socket and the socket contacts are not bent. Contact your retailer immediately if the PnP cap is missing, or if you see any damage to the PnP cap/socket contacts/motherboard components. Your place of purchase or local distributor will shoulder the cost of repair only if the damage is shipment/transit-related.
 - Keep the cap after installing the motherboard. Your place of purchase or local distributor will process Return Merchandise Authorization (RMA) requests only if the motherboard comes with the cap on the socket.
 - The product warranty does not cover damage to the socket contacts resulting from incorrect CPU installation/removal, or misplacement/loss/ incorrect removal of the PnP cap.
-

1.4.1 Installing the CPU

1. Locate the CPU socket on the motherboard.



Before installing the CPU, make sure that the socket box is facing towards you.

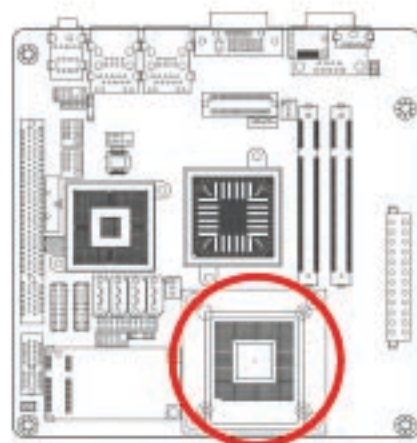

2. The processor socket comes with a screw to secure the processor, please unlock the screw first.

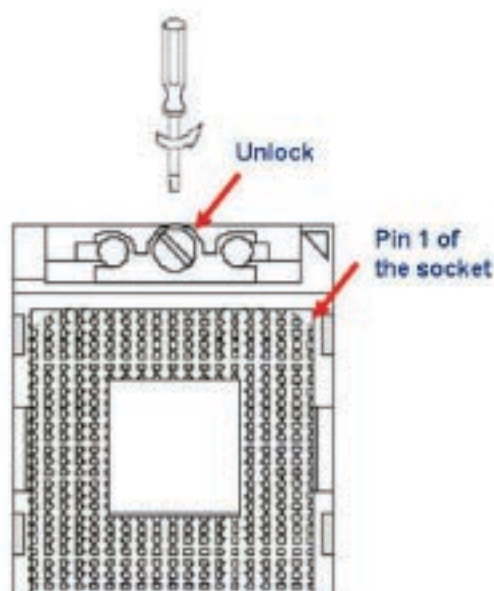

3. Position the CPU above the socket and the gold triangular mark on the CPU must align with pin 1 of the CPU socket.
4. Carefully insert the CPU into the socket until it fits in place 'Gold mark'.
5. Turn the screw to the lock position.

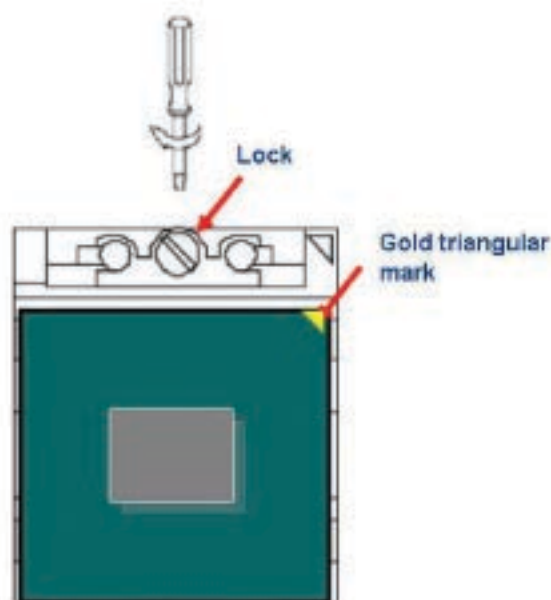

The CPU fits in only one correct orientation. DO NOT force the CPU into the socket to prevent bending the connectors on the socket and damaging the CPU.



After installation, make sure to plug-in the ATX power cable to the motherboard.

1.4.2 Installing the CPU Heatsink and Fan

The Intel® socket 479P Core Duo / Core Solo / Core 2 Duo CPU processor requires a specially designed heatsink and fan assembly to ensure optimum thermal condition and performance.



- Install the motherboard to the chassis before you install the CPU fan and heatsink assembly.
- When you buy a boxed Intel® processor, the package includes the CPU fan and heatsink assembly. If you buy a CPU separately, make sure that you use only Intel®-certified multi-directional heatsink and fan.



If you purchased a separate CPU heatsink and fan assembly, make sure that you have properly applied Thermal Interface Material to the CPU heatsink or CPU before you install the heatsink and fan assembly.

1. Place the heatsink on top of the installed CPU, making sure that the four fasteners match the holes on the motherboard.



Orient the heatsink and fan assembly such that the CPU fan cable is closest to the CPU fan connector.

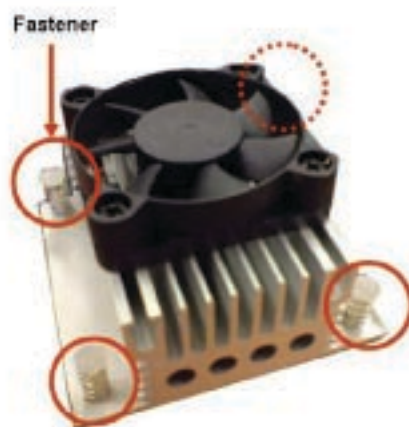
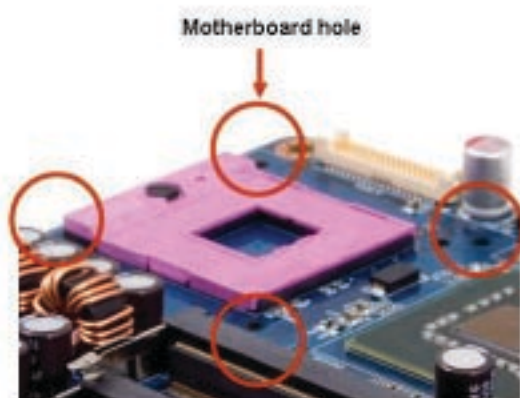

Make sure each fastener is oriented as shown, with the narrow groove directed outward.

2. Push down two fasteners at a time in a diagonal sequence to secure the heatsink and fan assembly in place.



3. Connect the CPU fan cable to the connector on the motherboard labelled **CPU_FAN1**.

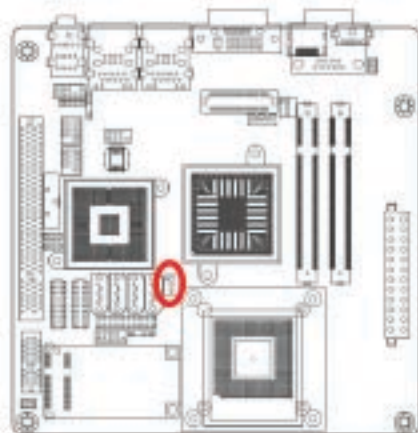

- Do not forget to connect the fan cables to the fan connectors. Insufficient air flow inside the system may damage the motherboard components, and hardware monitoring errors can occur if you fail to plug this connector.
- These are not jumpers! DO NOT place jumper caps on the fan connectors.

1.4.3 Uninstalling the CPU Heatsink and Fan

1. Disconnect the CPU fan cable from the connector on the motherboard.
2. Rotate each fastener counterclockwise.

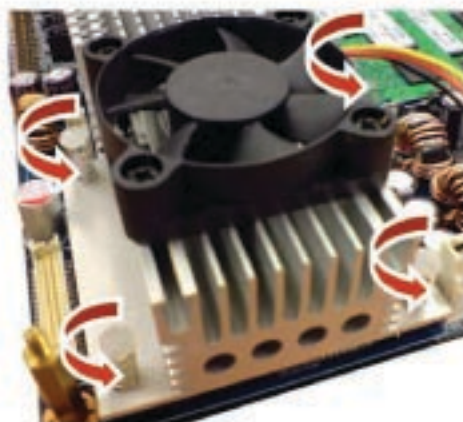

3. Pull up two fasteners at a time in a diagonal sequence to disengage the heatsink and fan assembly from the motherboard.

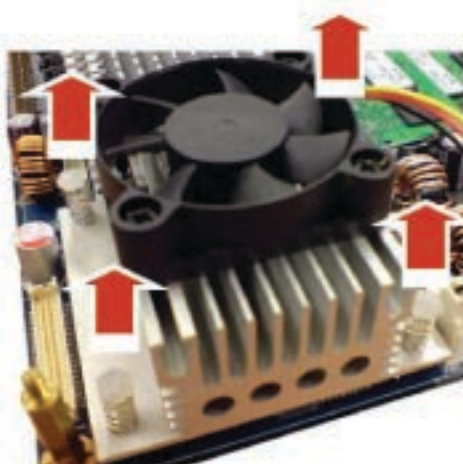
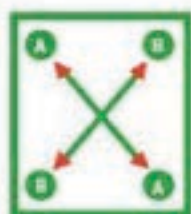

4. Carefully remove the heatsink and fan assembly from the motherboard.



Refer to the documentation in the boxed or stand-alone CPU fan package for detailed information on CPU fan installation.

1.5 System Memory

1.5.1 SO-DIMM Sockets Location

The motherboard comes with two 200-pin Double Data Rate 2 (DDR2) SO-DIMM sockets.

A DDR2 module has the same physical dimensions as a DDR SO-DIMM but has a 200-pin footprint compared to the 184-pin DDR DIMM. DDR2 SO-DIMMs are notched differently to prevent installation on a DDR SO-DIMM socket. The following figure illustrates the location of the sockets:

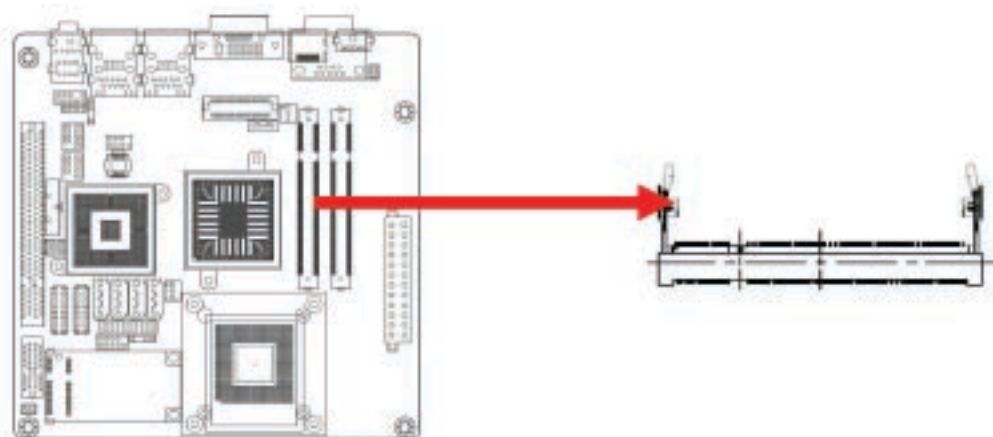

1.5.2 Memory Configurations

You can install 128 MB, 256 MB, 512 MB, 1GB and 2GB DDR2 SDRAM SO-DIMMs into the SO-DIMM sockets using the memory configurations in this section.



- Installing DDR2 SO-DIMM other than the recommended configurations may cause memory sizing error or system boot failure. Use any of the recommended configurations.
- Always install SO-DIMMs with the same CAS latency. For optimum compatibility, it is recommended that you obtain memory modules from the same vendor.
- Due to chipset resource allocation, the system may detect less than 1 GB system memory when you installed one 1 GB DDR2 memory modules.
- This motherboard does not support memory modules made up of 128 Mb chips or double-sided x16 memory modules.
Make sure that the memory frequency matches the CPU FSB (Front Side Bus). Refer to the Memory frequency/CPU FSB synchronization table.



- Memory frequency/CPU FSB synchronization

CPU FSB	DDR 2 DIMM Type	Memory Frequency
533/800MHz	DDR2 667	Max clock Freq; 333MHZ; 667Mb/s
	DDR2 800	Max clock Freq; 400MHZ; 800Mb/s

1.5.3 Installing a DDR2 SO-DIMM



Make sure to unplug the power supply before adding or removing SO-DIMMs or other system components. Failure to do so may cause severe damage to both the motherboard and the components.

1. Locate the SO-DIMM socket on the board.
2. Hold two edges of the SO-DIMM module carefully, and keep away of touching its connectors.
3. Align the notch key on the module with the rib on the slot.
4. Firmly press the modules into the socket automatically snaps into the mounting notch. Do not force the SO-DIMM module in with extra force as the SO-DIMM module only fit in one direction.

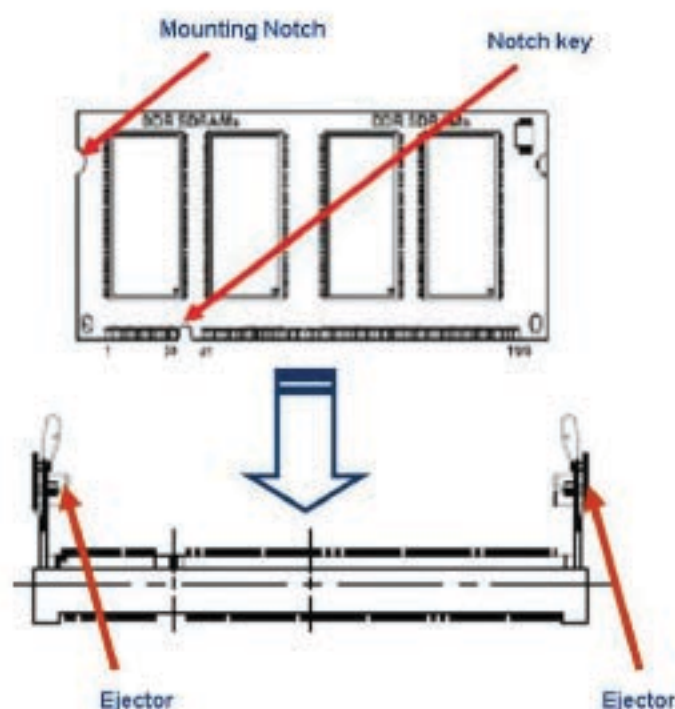

- A DDR2 SO-DIMM is keyed with a notch so that it fits in only one direction. DO NOT force a SO-DIMM into a socket to avoid damaging the SO-DIMM.
- The DDR2 SO-DIMM sockets do not support DDR SO-DIMMs. DO NOT install DDR SO-DIMMs to the DDR2 SO-DIMM socket.

1.5.4 Removing a DDR2 SO-DIMM

1. Press the two ejector tabs on the slot outward simultaneously, and then pull out the SO-DIMM module.

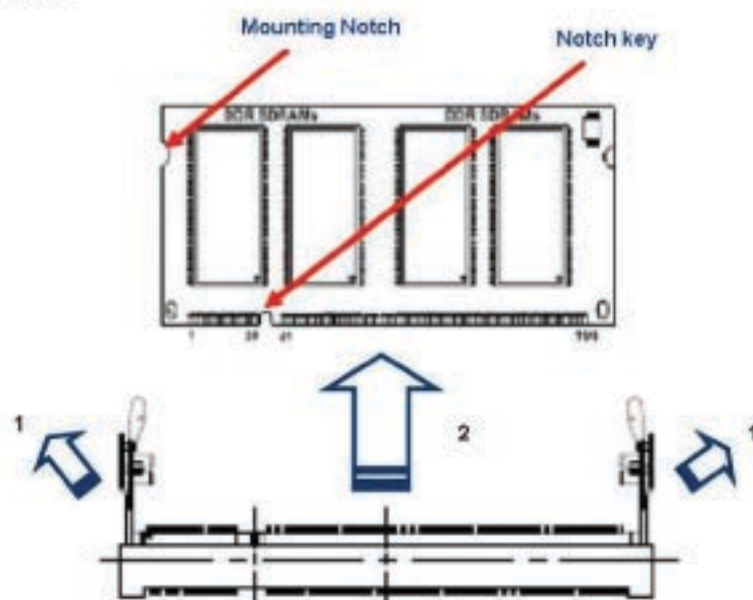

Support the SO-DIMM lightly with your fingers when pressing the ejector tabs. The SO-DIMM might get damaged when it flips out with extra force.

1.6 Expansion Slots

In the future, you may need to install expansion cards. The following sub-sections describe the slots and the expansion cards that they support.



Make sure to unplug the power cord before adding or removing expansion cards. Failure to do so may cause you physical injury and damage motherboard components.

1.6.1 Installing an Expansion Card

1. Before installing the expansion card, read the documentation that came with it and make the necessary hardware settings for the card.
2. Remove the system unit cover (if your motherboard is already installed in a chassis).
3. Remove the bracket opposite the slot that you intend to use. Keep the screw for later use.
4. Align the card connector with the slot and press firmly until the card is completely seated on the slot.
5. Secure the card to the chassis with the screw you removed earlier.
6. Replace the system cover.

1.6.2 Configuring an Expansion Card

After installing the expansion card, configure it by adjusting the software settings.

1. Turn on the system and change the necessary BIOS settings if any.
2. Assign an IRQ to the card if needed. Refer to the tables on the next page.
3. Install the software drivers for the expansion card.

1.6.3 Standard Interrupt Assignments

IRQ	Priority	Standard Function
0	1	System Timer
1	2	Keyboard Controller
2	-	Redirect to IRQ#9
3	11	IRQ holder for PCI steering*
4	12	Communications Port (COM1)*
5	13	IRQ holder for PCI steering*
6	14	Floppy Disk Controller
7	15	Printer Port (LPT)*
8	3	System CMOS/Rear Time
9	4	IRQ holder for PCI steering*
10	5	IRQ holder for PCI steering*
11	6	IRQ holder for PCI steering*
12	7	PS/2 Compatible Mouse Port*
13	8	Numeric Data Processor
14	9	Primary IDE Channel
15	10	Secondary IDE Channel

* These IRQs are usually available for ISA or PCI device.

1.6.4 PCI Slots

IX45GM has one PCI slots. The PCI slots support cards such as a LAN card, SCSI card, USB card, and other cards that comply with PCI specifications. The figure shows a LAN card installed on a PCI slot.



1.6.5 PCI Express x1

This motherboard supports PCI Express x1 network cards, SCSI cards and other cards that comply with the PCI Express specifications. The figure shows the type of network card that can be installed on the PCI Express x1 slot.



1.6.6 Mini PCI Express x 1

This motherboard supports Mini PCI Express wireless LAN, and TV tuner device.



1.7 Jumpers

1.7.1 Clear CMOS (CLRRTC1)

This jumper allows you to clear the Real Time Clock (RTC) RAM in CMOS. You can clear the CMOS memory of date, time, and system setup parameters by erasing the CMOS RTC RAM data. The onboard button cell battery powers the RAM data in CMOS, which include system setup information such as system passwords. To erase the RTC RAM:

1. Turn OFF the computer and unplug the power cord.
2. Remove the onboard battery.
3. Move the jumper cap from pins 1-2 (default) to pins 2-3. Keep the cap on pins 2-3 for about 5~10 seconds, then move the cap back to pins 1-2.
4. Re-install the battery.
5. Plug the power cord and turn ON the computer.
6. Hold down the key during the boot process and enter BIOS setup to re-enter data.



Except when clearing the CMOS, never remove the cap on CLRRTC jumper default position. Removing the cap will cause system boot failure!

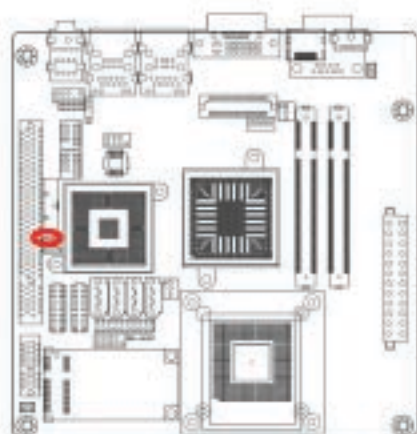

Normal (Default)



Clear RTC



1.7.2 COM1 RI/+5V/+12V Selection (JCOMPWR3)

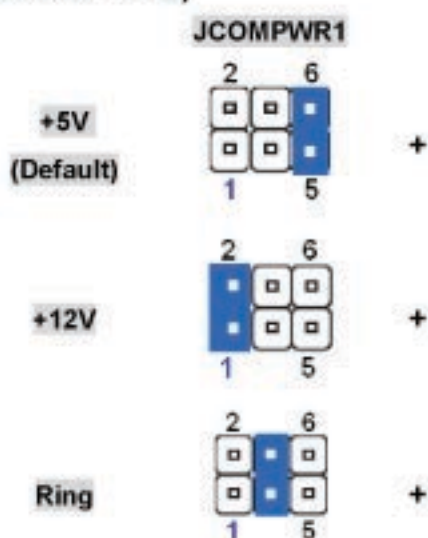
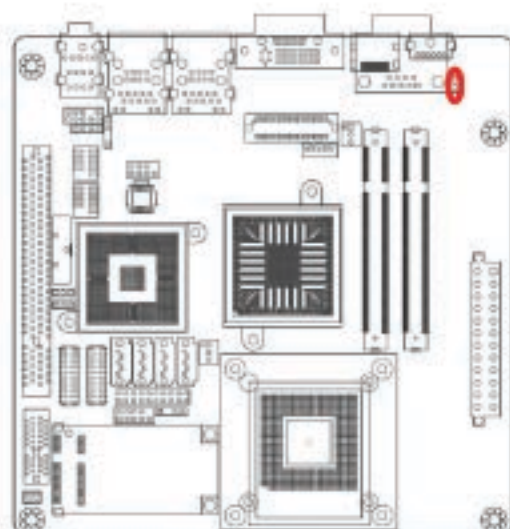

1.7.3 COM2 RI/+5V/+12V Selection (JCOMPWR2)

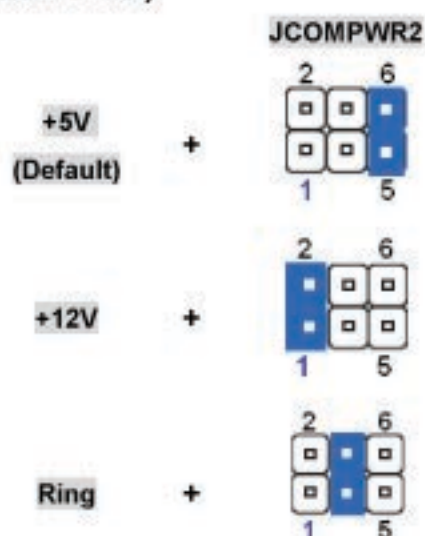
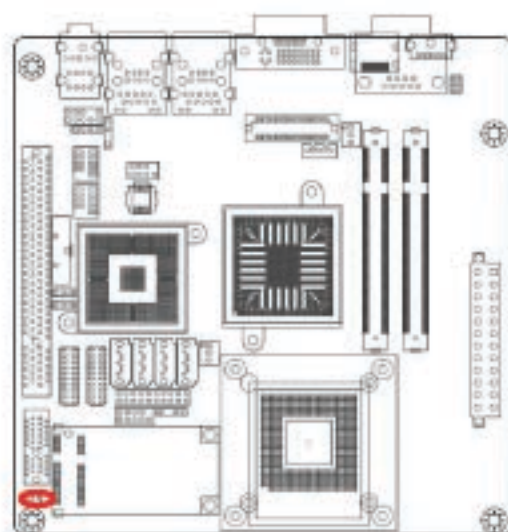

1.8 Connectors

1.8.1 Rear Panel Connectors

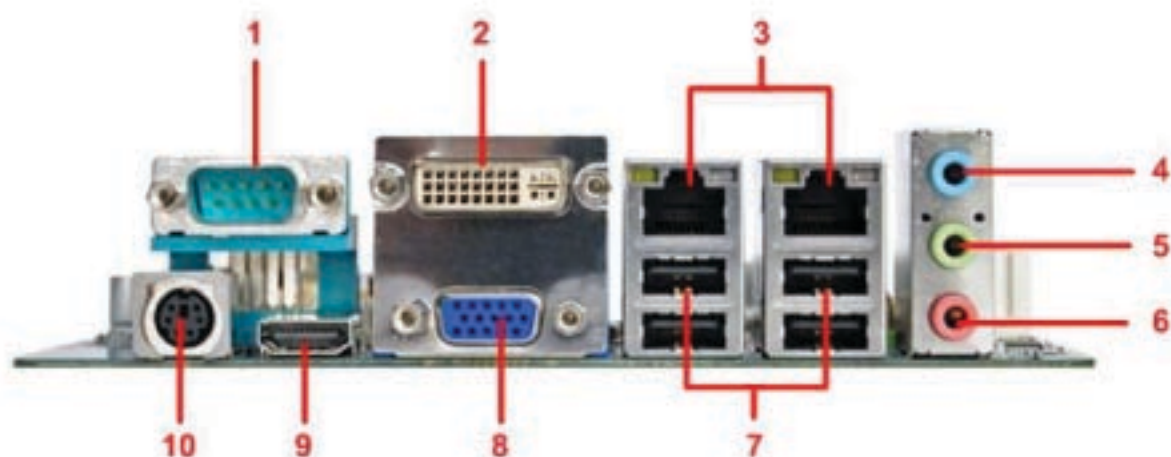

No	Label	Function	Description
1	COM1	Serial port connector	D-sub 9-pin, male
2	VGA_DVI-D1	DVI port	Digital Visual Interface connector
3	LAN_USB1, LAN_USB2	LAN (RJ-45) connector	This port allows Gigabit connection to a Local Area Network (LAN) through a network hub. Refer to the table below for the LAN port LED indications. The optional 10/100/1000 Mbps LAN controller allows 10/100/1000 Mbps connection to a Local Area Network (LAN) through a network hub.

ACT/LINK LED SPEED LED

LAN port

ACT / LINK LED		SPEED LED	
Status	Description	Status	Description
OFF	No link	OFF	10Mbps connection
Orange	Linked	ORANGE	100Mbps connection
Blinking	Data activity	GREEN	1Gbps connection

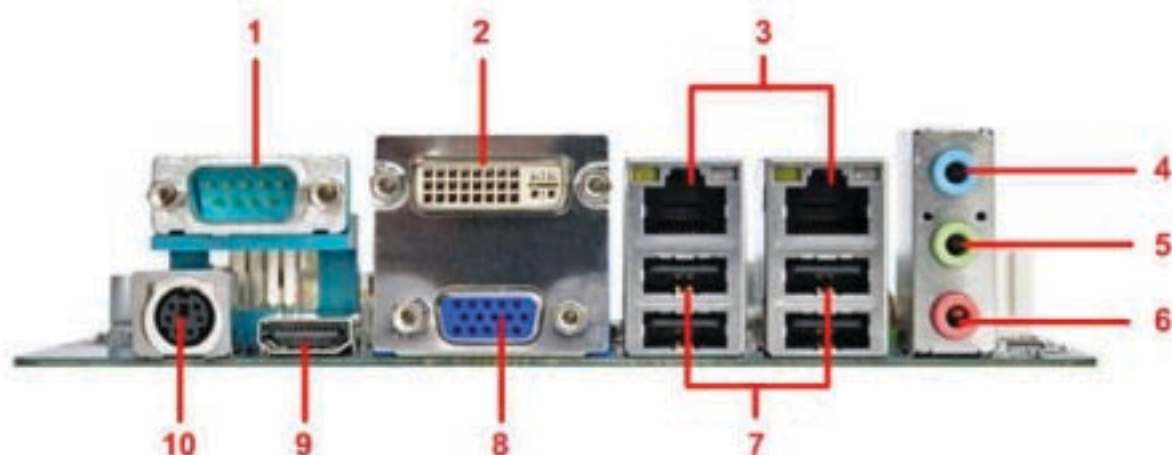

No	Label	Function	Description
4	AUDIO1	Line-In port (Light Blue).	This port connects a tape, CD, DVD player, or other audio sources.
5	AUDIO1	Line-Out port (Lime)	This port connects a headphone or a speaker. In 4-channel, 6-channel, and 8-channel configuration, the function of this port becomes Front Speaker Out.
6	AUDIO1	Microphone port (Pink)	This port connects a microphone.
7	USB1, USB2	USB 2.0 connector	These four 4-pin Universal Serial Bus (USB) ports are available for connecting USB 2.0 devices.
8	VGA_DVI-D1	VGA port	D-sub15-pin VGA port connects to a VGA monitor.
9	HDMI1	HDMI connector	High Definition Media Interface 19P connector
10	KBMS1	PS/2 Keyboard/Mouse connector	The standard PS/2 DIN connector is for a PS/2 Keyboard or mouse.

1.8.2 ATX Power Connector (EATXPWR1)

These connectors are for ATX power supply plugs. The power supply plugs are designed to fit these connectors in only one orientation. Find the proper orientation and push down firmly until the connectors completely fit.

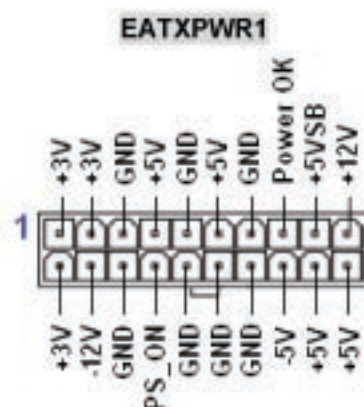
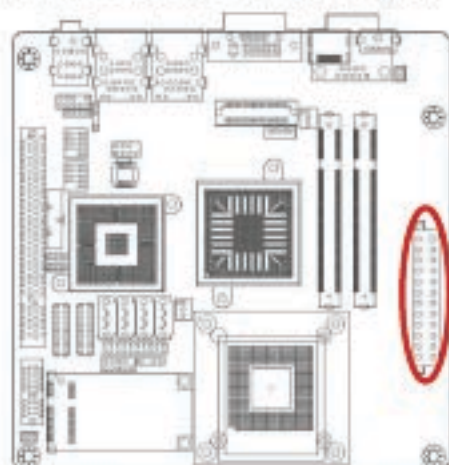

1.8.3 Amplifier Connector (JAMP1)

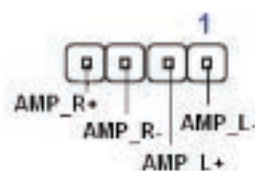
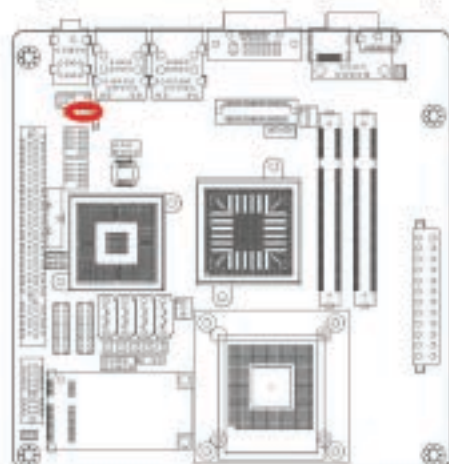

Important notes on the Motherboard Power Requirements

- Make sure that your ATX 12V power supply can provide 8A on the +12V lead and at least 1A on the +5-volt standby lead (+5VSB). The minimum recommended wattage is 230W, or 300W for a fully configured system. The system can become unstable and might experience difficulty powering up if the power supply is inadequate.
- You must install a PSU with a higher power rating if you intend to install additional devices.

1.8.4 Serial Port 2-3 Connector (COM2, COM3)

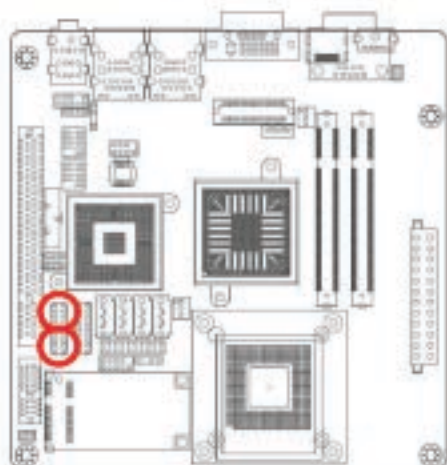

1

DDCD2_N	<input type="checkbox"/>	○	DDSR2_N
RRXD2	○	○	RRTS2_N
TTXD2	○	○	CCTS2_N
DDTR2_N	○	○	RRI2_M
GND	○	○	GND
DDCD3_N	○	○	DDSR3_N
RRXD3	○	○	RRTS3_N
TTXD3	○	○	CCTS3_N
DDTR3_N	○	○	RRI3_N
GND	○	○	GND

1.8.5 Serial Port 4-5 Connector (COM4, COM5)

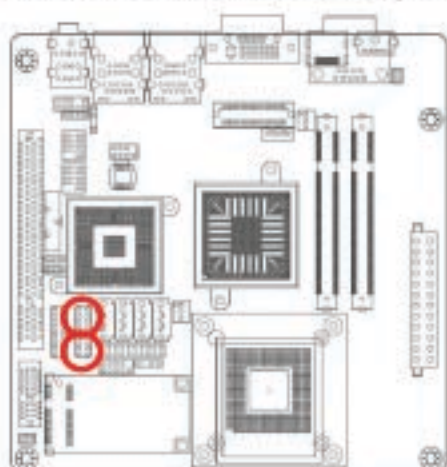

1

DDCD2_N	<input type="checkbox"/>	○	DDSR2_N
RRXD2	○	○	RRTS2_N
TTXD2	○	○	CCTS2_N
DDTR2_N	○	○	RRI2_M
GND	○	○	GND
DDCD3_N	○	○	DDSR3_N
RRXD3	○	○	RRTS3_N
TTXD3	○	○	CCTS3_N
DDTR3_N	○	○	RRI3_N
GND	○	○	GND

1.8.6 CPU Fan Connector (CPU_FAN1)

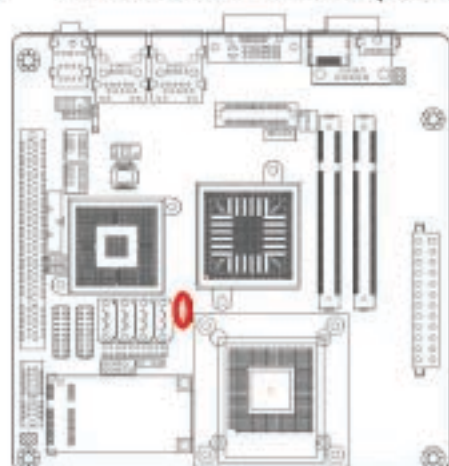

- Do not forget to connect the fan cables to the fan connectors. Insufficient air flow inside the system may damage the motherboard components, and hardware monitoring errors can occur if you fail to plug this connector.
- These are not jumpers! DO NOT place jumper caps on the fan connectors.

1.8.7 System Fan Connector (SYS_FAN1)

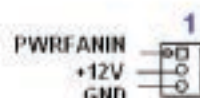
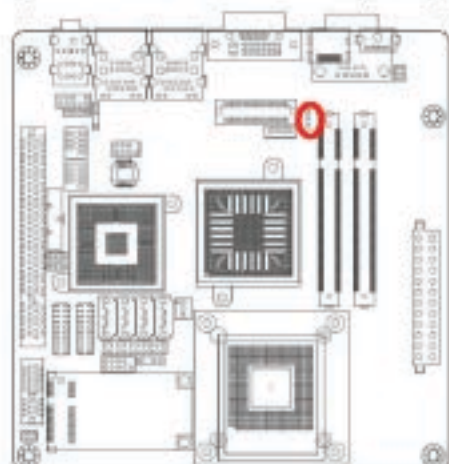

- Do not forget to connect the fan cables to the fan connectors. Insufficient air flow inside the system may damage the motherboard components, and hardware monitoring errors can occur if you fail to plug this connector.
- These are not jumpers! DO NOT place jumper caps on the fan connectors.

1.8.8 System Panel Connector (FPIO1)

This connector supports several chassis-mounted functions.

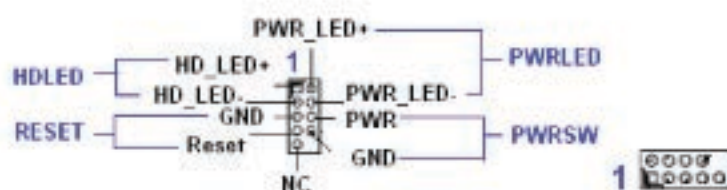
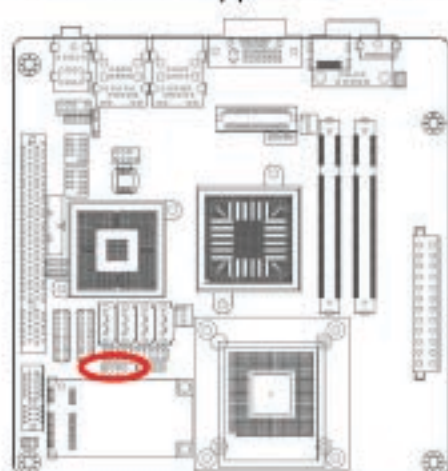

- **System Power LED (2-pin PWRLED)**

This 2-pin connector is for the system power LED. Connect the chassis power LED cable to this connector. The system power LED lights up when you turn on the system power, and blinks when the system is in sleep mode.

- **ATX Power Button/Soft-off Button (2-pin PWRSW)**

This connector is for the system power button. Pressing the power button turns the system on or puts the system in sleep or soft-off mode depending on the BIOS settings. Pressing the power switch for more than four seconds while the system is ON turns the system OFF.

- **Hard Disk Drive Activity LED (2-pin HDLED)**

This 2-pin connector is for the HDD Activity LED. Connect the HDD Activity LED cable to this connector. The IDE LED lights up or flashes when data is read from or written to the HDD.

- **Reset Button (2-pin RESET)**

This 2-pin connector is for the chassis-mounted reset button for system reboot without turning off the system power.

1.8.9 Digital I/O Connector

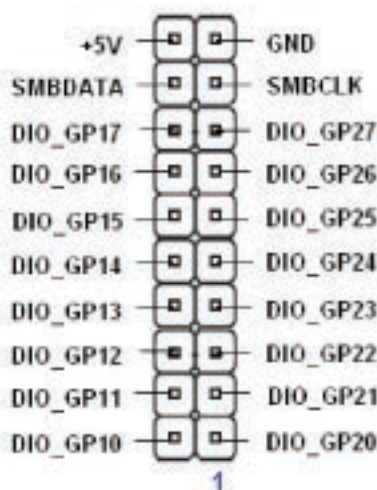
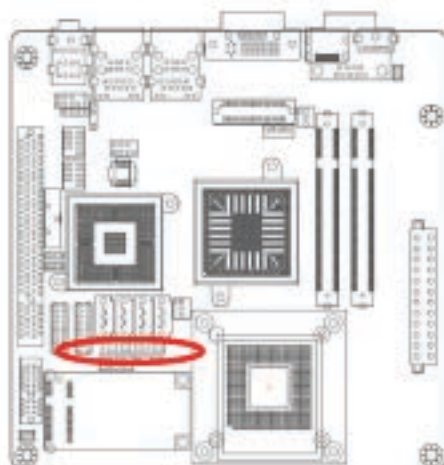

1.8.10 LVDS Connector (JLVDS1)

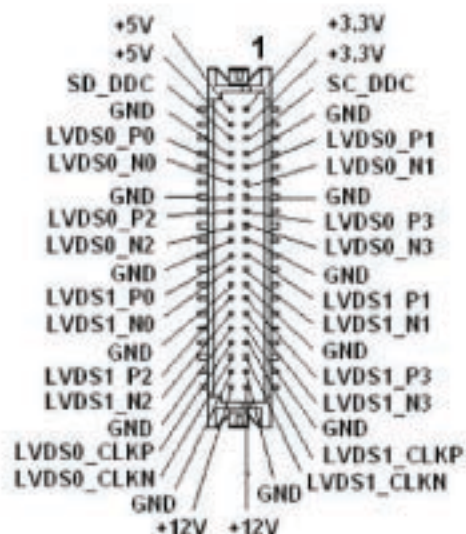
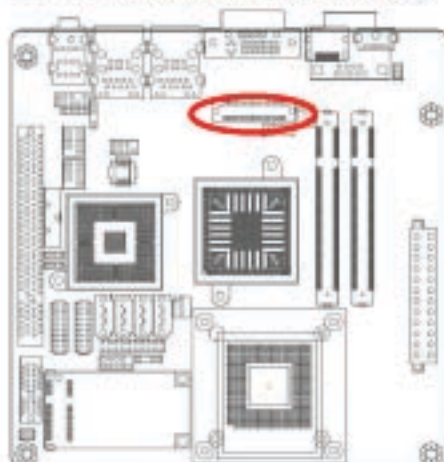

1.8.11 LCD Inverter Connector (JBKL1)

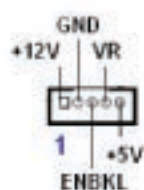
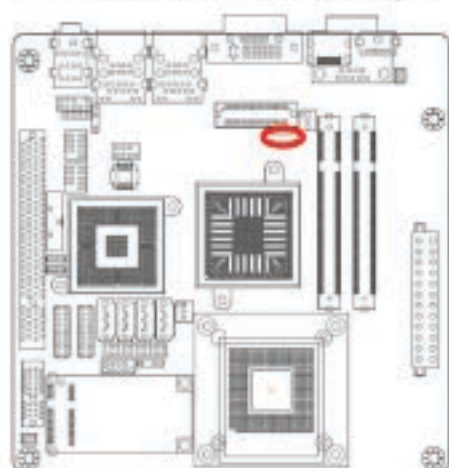

● Signal Description

Signal	Signal Description
VR	Bright adjust. $V_{adj}=0.75V \sim 4.25V$ (Recommended: $4.7K\Omega$, $> 1/16W$)
ENBKL	LCD backlight ON/OFF control signal

1.8.12 SPI Connector (JSPI1)

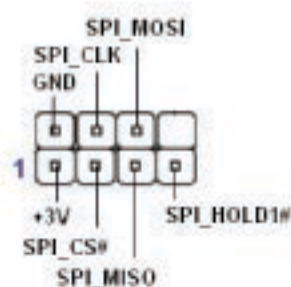
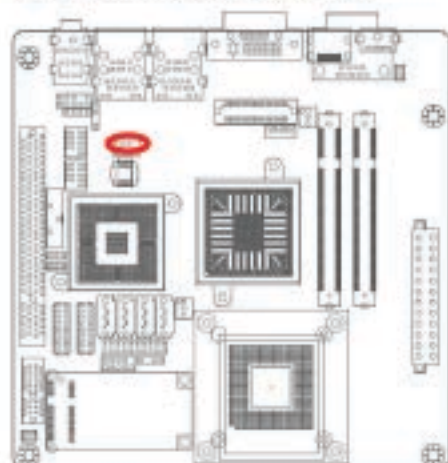

1.8.13 Digital Audio Connector (SPDIF_OUT1)

This connector is for an additional Sony/Philips Digital Interface (S/PDIF) port(s). Connect the S/PDIF module cable to this connector, then install the module to a slot opening at the back of the system chassis.

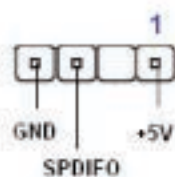
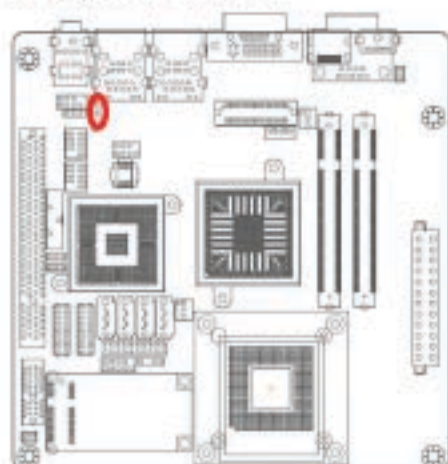

The S/PDIF module is purchased separately.

1.8.14 Serial SATA Connector (SATA1, SATA2, SATA3, SATA4)

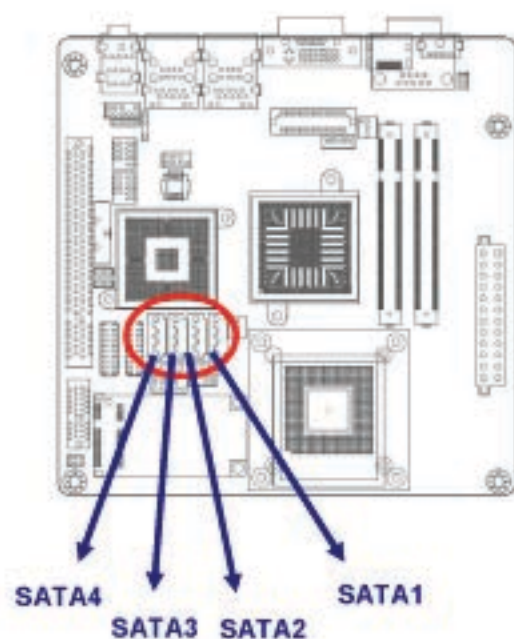

SATA1

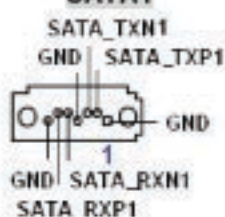

SATA2

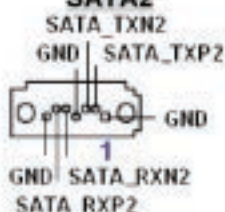

SATA3

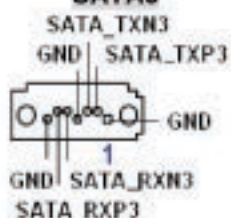

SATA4

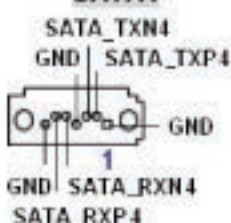

- Install the Windows® 2000 Service Pack 4 or the Windows® XP Service Pack1 before using Serial ATA.
- When using the connectors in Standard IDE mode, connect the primary (boot) hard disk drive to the SATA1 connector.

1.8.15 USB 2.0 Connector (USB1, USB2)

These connectors are for USB 2.0 ports. Connect the USB/GAME module cable to any of these connectors, then install the module to a slot opening at the back of the system chassis. These USB connectors comply with USB 2.0 specification that supports up to 480 Mbps connection speed.

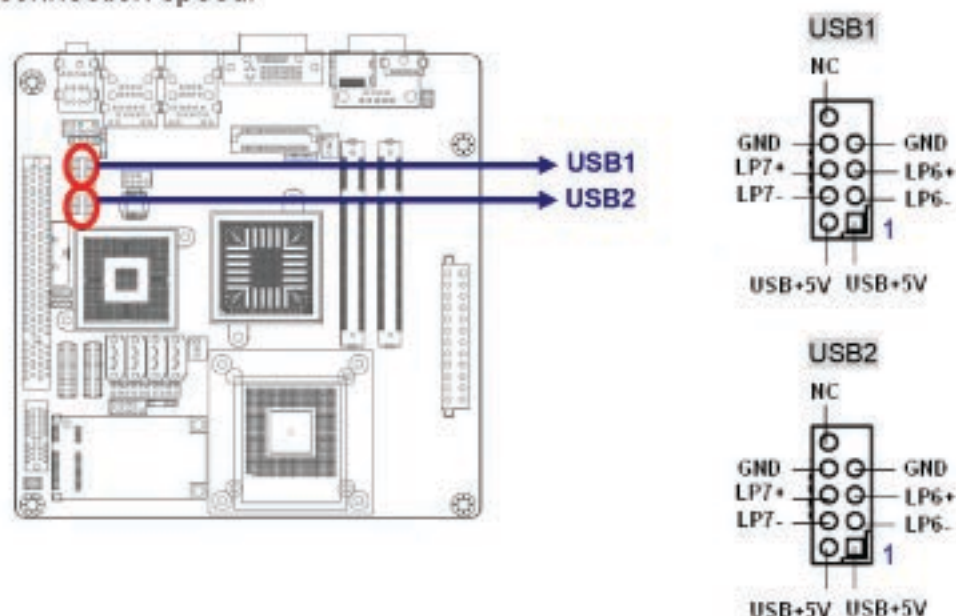

Never connect a **1394 cable** to the USB connectors. Doing so will damage the motherboard!



The USB module is purchased separately.

This chapter tells how to change the system settings through the BIOS Setup menus. Detailed descriptions of the BIOS parameters are also provided.

BIOS Setup **2**

2.1 Managing and updating your BIOS

2.1.1 Creating a bootable floppy disk

1. Do either one of the following to create a bootable floppy disk.

DOS environment

- a. Insert a 1.44MB floppy disk into the drive.
- b. At the DOS prompt, type format **A:/S** then press <Enter>.

Windows® XP environment

- a. Insert a 1.44 MB floppy disk to the floppy disk drive.
- b. Click **Start** from the Windows® desktop, then select **My Computer**.
- c. Select the 3 1/2 Floppy Drive icon.
- d. Click **File** from the menu, then select **Format**. A **Format 3 1/2 Floppy Disk** window appears.
- e. Select **Create an MS-DOS startup disk** from the format options field, then click **Start**.

Windows® 2000 environment

To create a set of boot disks for Windows® 2000:

- a. Insert a formatted, high density 1.44 MB floppy disk into the drive.
- b. Insert the Windows® 2000 CD to the optical drive.
- c. Click **Start**, then select **Run**.
- d. From the Open field, type **D:\bootdisk\makeboot a:** assuming that D: is your optical drive.
- d. Press <Enter>, then follow screen instructions to continue.

2. Copy the original or the latest motherboard BIOS file to the bootable floppy disk.

2.2 BIOS setup program

The main BIOS setup menu is the first screen that you can navigate. Each main BIOS setup menu option is described in this user's guide.

The Main BIOS setup menu screen has two main frames. The left frame displays all the options that can be configured. "Grayed-out" options cannot be configured. Options in blue can be.

The right frame displays the key legend. Above the key legend is an area reserved for a text message. When an option is selected in the left frame, it is highlighted in white.

Often a text message will accompany it.



- The default BIOS settings for this motherboard apply for most conditions to ensure optimum performance. If the system becomes unstable after changing any BIOS settings, load the default settings to ensure system compatibility and stability. Select the **Load Default Settings** item under the Exit Menu. See section "2.9 Exit Menu."
- The BIOS setup screens shown in this section are for reference purposes only, and may not exactly match what you see on your screen.
- Visit the Advansus website to download the latest BIOS file for this motherboard.

2.2.1 Legend Box

The BIOS setup/utility uses a key-based navigation system called hot keys. Most of the BIOS setup utility hot keys can be used at any time during the setup navigation process.

These keys include <F1>, <F10>, <Enter>, <ESC>, <Arrow> keys, and so on.

The keys in the legend bar allow you to navigate through the various setup menus.

Key(s)	Function Description
←, → Left/Right	The <i>Left and Right</i> <Arrow> keys allow you to select an setup screen. For example: Main screen, Advanced screen, Chipset screen, and so on.
↑, ↓ Up/Down	The <i>Up and Down</i> <Arrow> keys allow you to select an setup item or sub-screen.
+ , - Plus/Minus	The <i>Plus and Minus</i> <Arrow> keys allow you to change the field value of a particular setup item. For example: Date and Time.

Tab	The <Tab> key allows you to select setup fields.
F1	The <F1> key allows you to display the <i>General Help</i> screen. Press the <F1> key to open the <i>General Help</i> screen.
F10	The <F10> key allows you to save any changes you have made and exit Setup. Press the <F10> key to save your changes.
ESC	The <Esc> key allows you to discard any changes you have made and exit the Setup. Press the <Esc> key to exit the setup without saving your changes.
Enter	The <Enter> key allows you to display or change the setup option listed for a particular setup item. The <Enter> key can also allow you to display the setup sub- screens.

2.2.2 List Box

This box appears only in the opening screen. The box displays an initial list of configurable items in the menu you selected.

2.2.3 Sub-menu

Note that a right pointer symbol (►) appears to the left of certain fields. This pointer indicates that you can display a sub-menu from this field. A sub-menu contains additional options for a field parameter. To display a sub-menu, move the highlight to the field and press <Enter>. The sub-menu appears. Use the legend keys to enter values and move from field to field within a sub-menu as you would within a menu. Use the <Esc> key to return to the main menu.

Take some time to familiarize yourself with the legend keys and their corresponding functions. Practice navigating through the various menus and submenus. While moving around through the Setup program, note that explanations appear in the Item Specific Help window located to the right of each menu. This window displays the help text for the currently highlighted field.

2.3 Main Setup

When you first enter the Setup Utility, you will enter the Main setup screen. You can always return to the Main setup screen by selecting the *Main* tab. There are two Main Setup options. They are described in this section. The Main BIOS Setup screen is shown below.

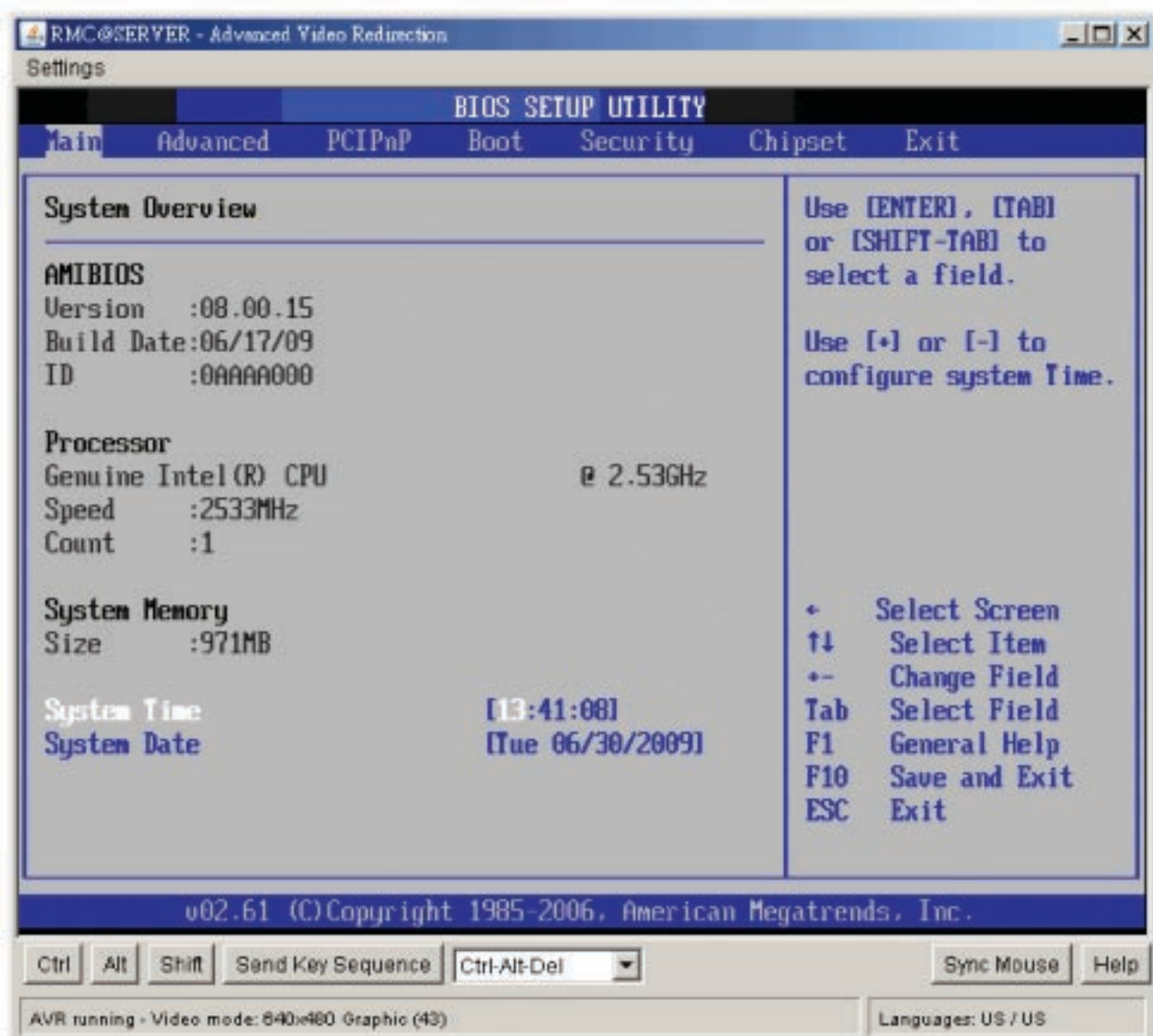

- **System Time/System Date**

Use this option to change the system time and date. Highlight *System Time* or *System Date* using the <Arrow> keys. Enter new values through the keyboard. Press the <Tab> key or the <Arrow> keys to move between fields. The date must be entered in MM/DD/YY format. The time is entered in HH:MM:SS format.

Note: The time is in 24-hour format. For example, 5:30 A.M. appears as 05:30:00, and 5:30P.M. as 17:30:00.

2.4 Advanced BIOS Setup

Select the *Advanced* tab from the setup screen to enter the Advanced BIOS Setup screen. You can select any of the items in the left frame of the screen, such as SuperIO Configuration, to go to the sub menu for that item. You can display an Advanced BIOS Setup option by highlighting it using the <Arrow> keys. All Advanced BIOS Setup options are described in this section. The Advanced BIOS Setup screen is shown below. The sub menus are described on the following pages.

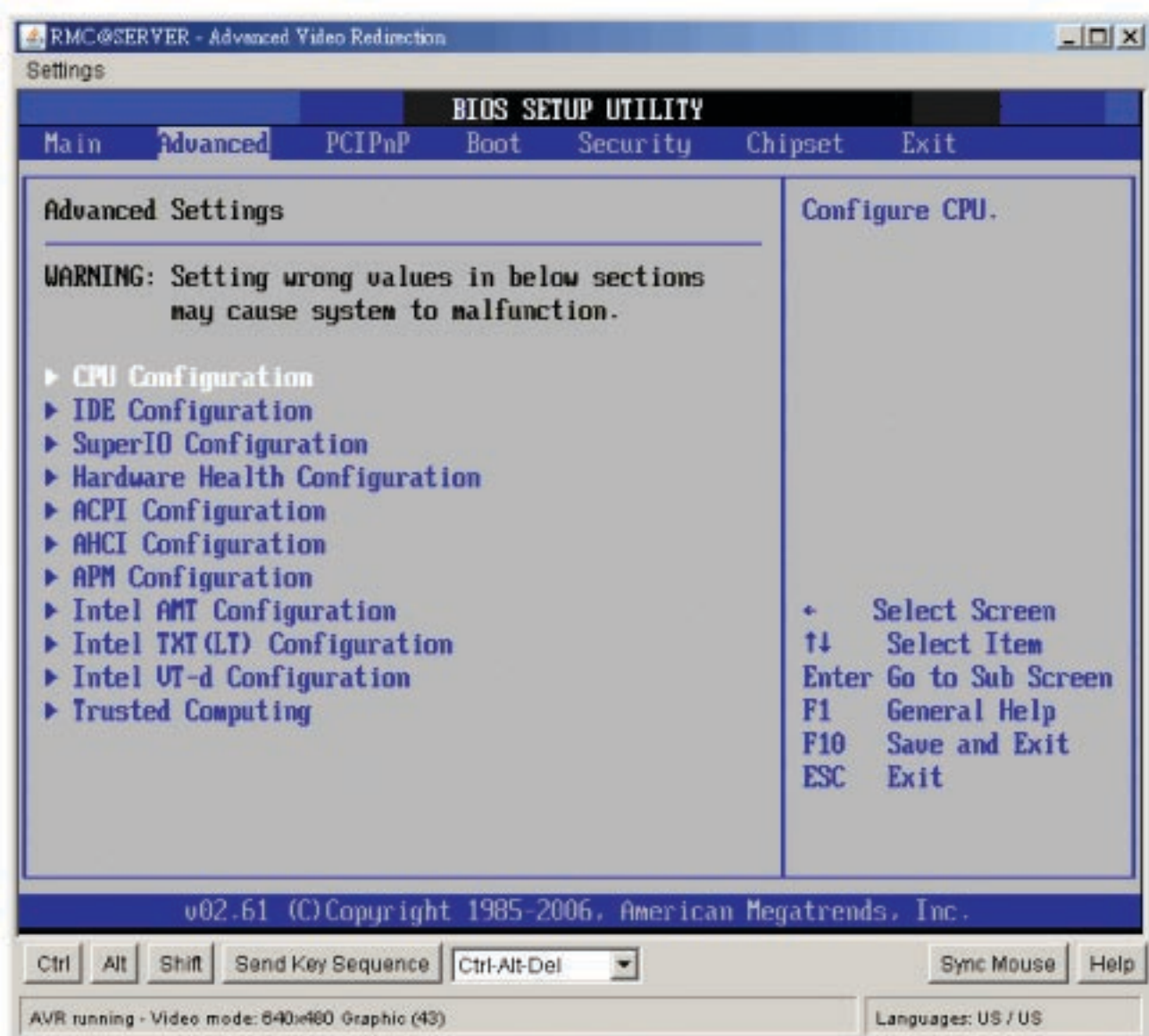

CPU Configuration Setting

You can use this screen to select options for the CPU Configuration Settings. Use the up and down <Arrow> keys to select an item. Use the <Plus> and <Minus> keys to change the value of the selected option. A description of the selected item appears on the right side of the screen. The settings are described on the following pages.

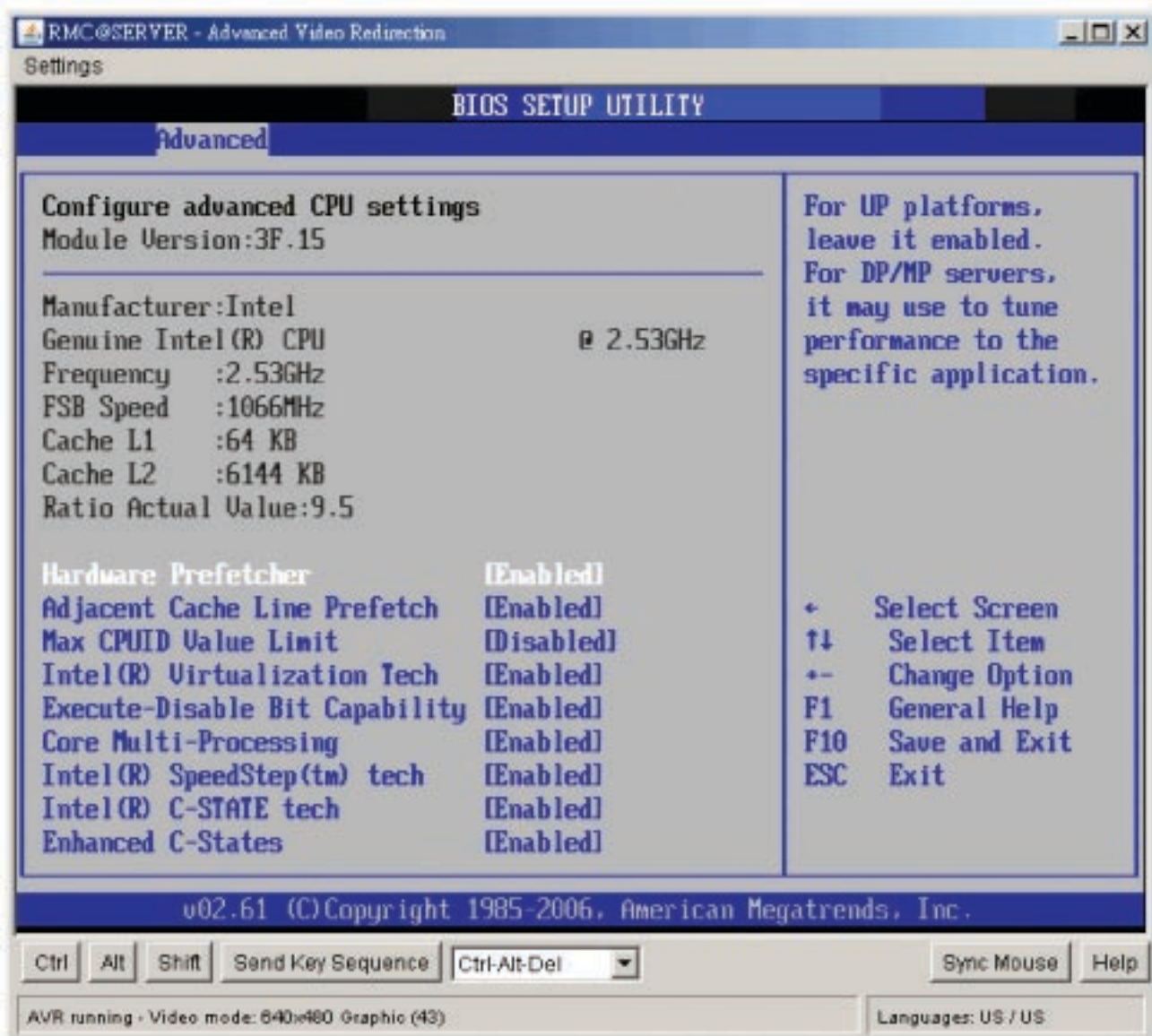

- **Hardware Prefetcher**

The choices of Hardware Prefetcher which prefetchs data from memory to L2 cache are Disabled, and Enabled.

- **Adjacent Cache Line Prefetch**

The choices of Adjacement Cache Line Prefetch which automatically fetches an extra 64-byte cache line are Enabled, Disabled.

- **Max CPUID Value Limit**

The choices of Max CPUID Value Limit are Disabled, and Enabled.

- **Intel® Virtualization Tech**

The choices of Intel® Virtualization Tech are Enabled, Disabled.

- **Execute-Disable Bit Capability**

The choices of Execute-Disable Bit Capability are Enabled, Disabled.

- **Core Multi-Processing**

The item is to enable or disable the Core Multi-processing function.

- **Intel® SpeedStep™ tech**

The choices of Execute-Disable Bit Capability are Enabled, Disabled.

- **Intel® C-State tech**

The choices of Execute-Disable Bit Capability are Enabled, Disabled.

- **Enhanced C-States**

The choices of Execute-Disable Bit Capability are Enabled, Disabled.

IDE Configuration Setting

You can use this screen to select options for the IDE Configuration Settings. Use the up and down <Arrow> keys to select an item. Use the <Plus> and <Minus> keys to change the value of the selected option. A description of the selected item appears on the right side of the screen. The settings are described on the following pages.

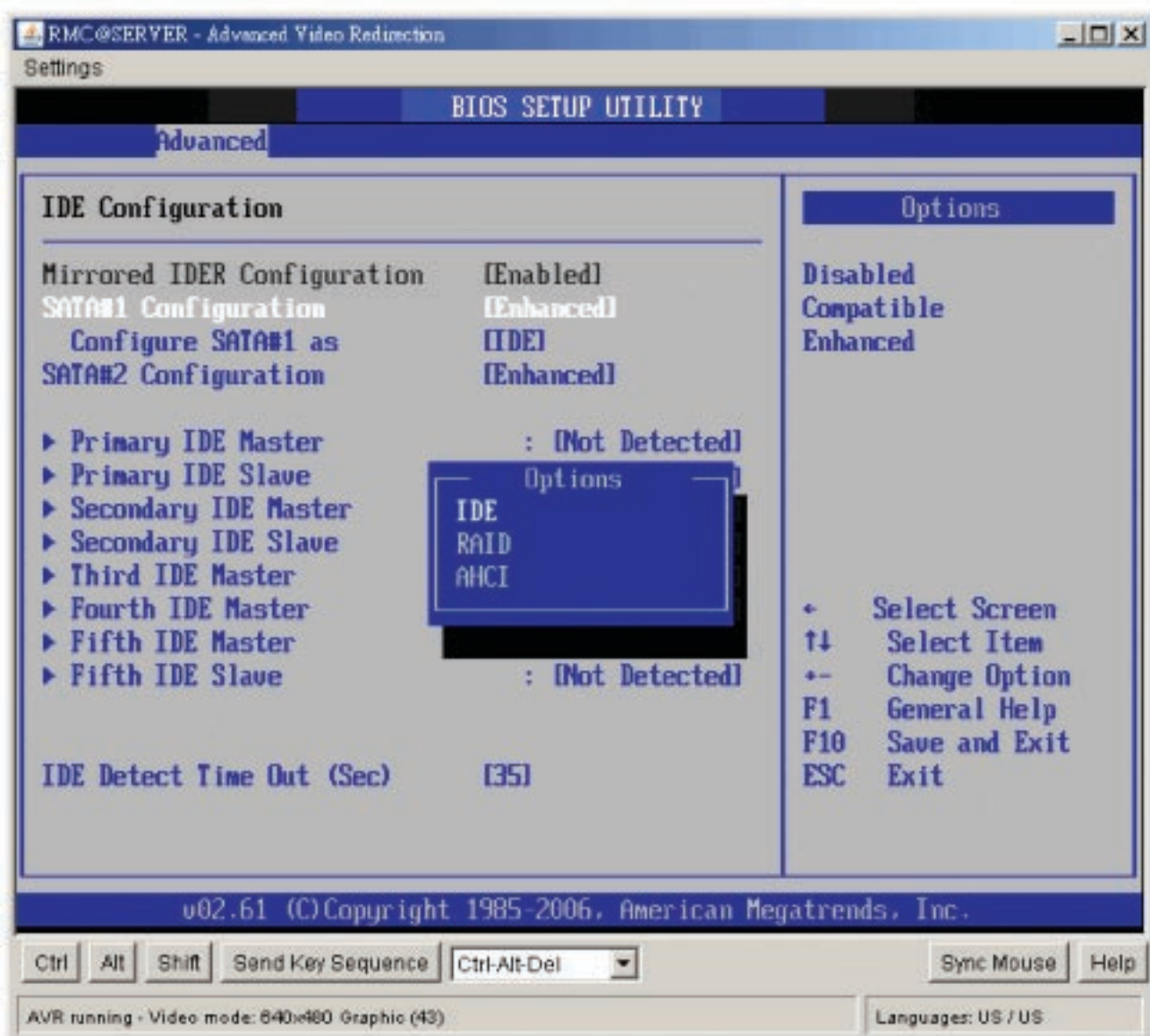

- **Mirrored IDER Configuration**

The choices of Mirrored IDER configuration are Disabled, and Enabled.

- **SATA#1 Configuration**

The choices of SATA configuration are Disabled, Compatible, and Enhanced.

- **Configure SATA #1 as**

This item allows to configure SATA as IDE, RAID, or AHCI.

- **SATA#2 Configuration**

The choices of SATA configuration are Disabled and Enhanced.

- **Primary/Secondary IDE Master/Slave, Third/Fourth IDE Master, Fifth IDE Master/Slave**

Select one of the hard disk drives to configure it. Press <Enter> to access its the sub menu. The options on the sub menu are described in the following sections.

- **IDE Detect Time Out (Sec)**

Set this option to stop the AMIBIOS from searching for IDE devices within the specified number of seconds. Basically, this allows you to fine-tune the settings to allow for faster boot times. Adjust this setting until a suitable timing that can detect all IDE disk drives attached is found.

The default setting is 35.

Option	Description
0	This value is the best setting to use if the onboard IDE controllers are set to a specific IDE disk drive in the AMIBIOS.
5	Set this value to stop the AMIBIOS from searching the IDE bus for IDE disk drives in five seconds. A large majority of ultra ATA hard disk drives can be detected well within five seconds.
10	Set this value to stop the AMIBIOS from searching the IDE bus for IDE disk drives in 10 seconds.
15	Set this value to stop the AMIBIOS from searching the IDE bus for IDE disk drives in 15 seconds.
20	Set this value to stop the AMIBIOS from searching the IDE bus for IDE disk drives in 20 seconds.
25	Set this value to stop the AMIBIOS from searching the IDE bus for IDE disk drives in 25 seconds.
30	Set this value to stop the AMIBIOS from searching the IDE bus for IDE disk drives in 30 seconds.
35	35 is the default value. It is the recommended setting when all IDE connectors are set to AUTO in the AMIBIOS setting.

Note: Different IDE disk drives take longer for the BIOS to locate than others do.

AHCI Configuration

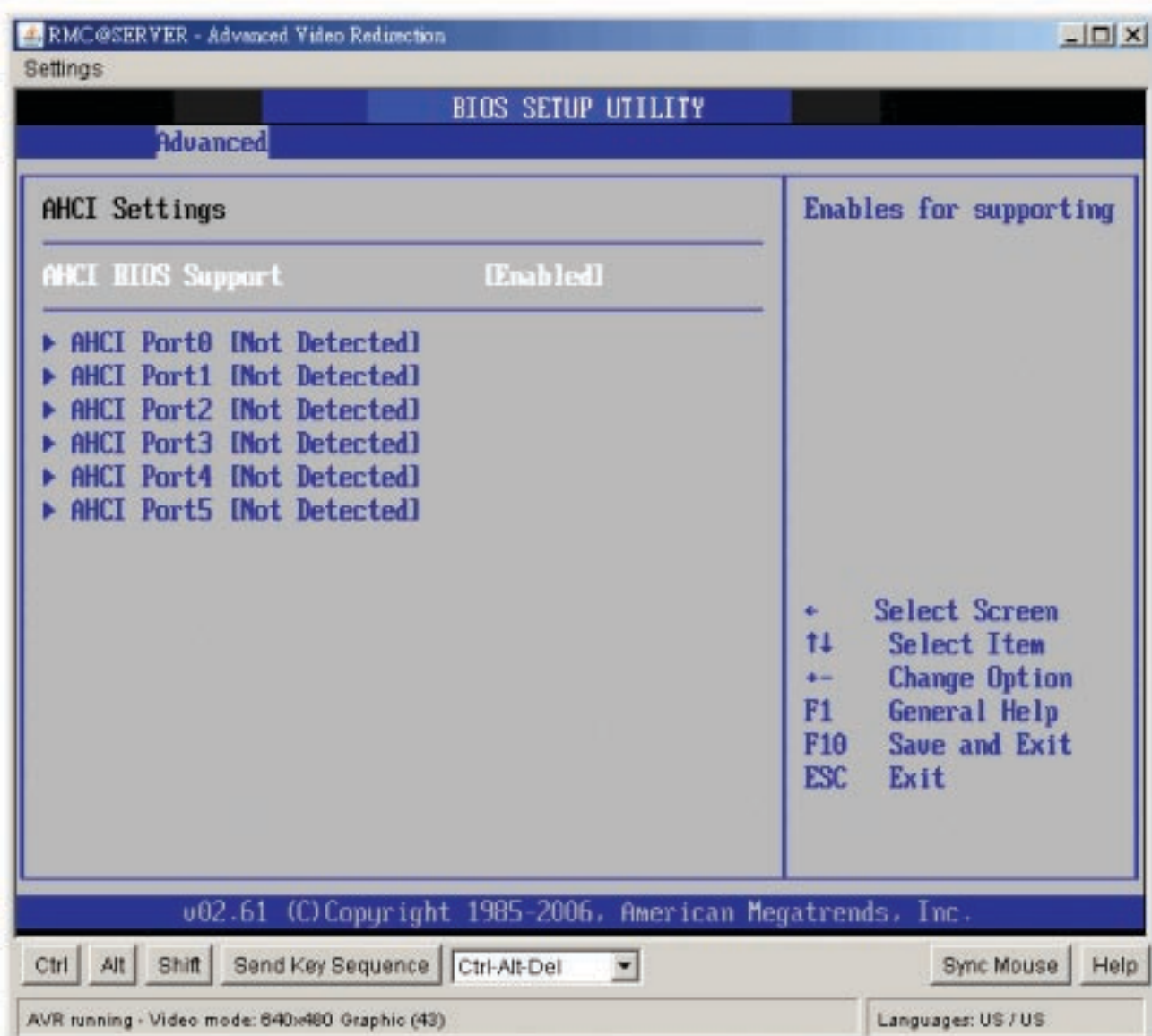

- AHCI BIOS Support

Enables for supporting AHCI BIOS. The choices are Enabled or Disabled.

2.4.1 Super I/O Configuration

You can use this screen to select options for the Super I/O settings. Use the up and down <Arrow> keys to select an item. Use the <Plus> and <Minus> keys to change the value of the selected option. The settings are described on the following pages. The screen is shown below.

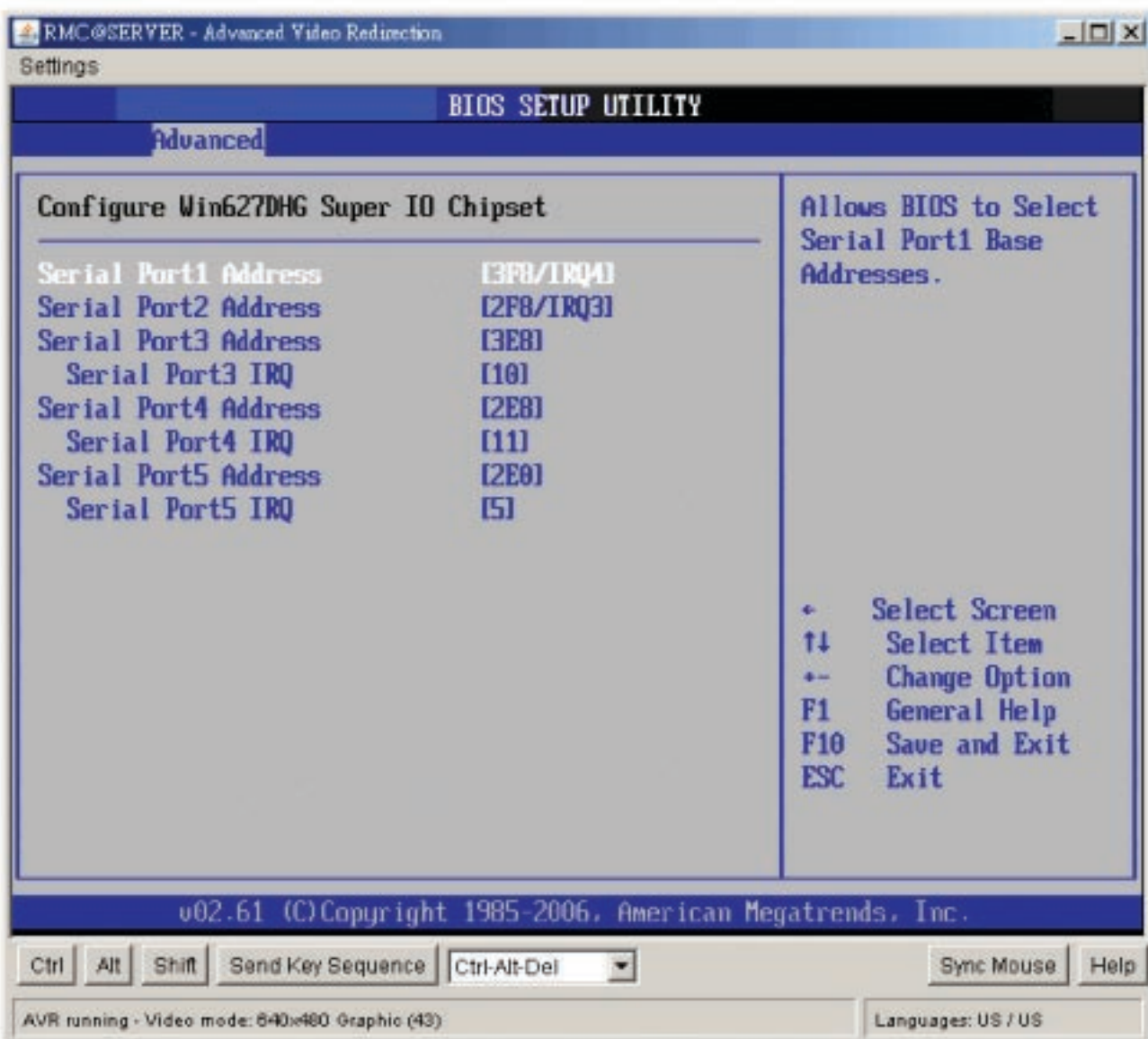

- **Serial Port1 Address**

This option specifies the base I/O port address and Interrupt Request address of serial port 1. The Optimal setting is 3F8/IRQ4.

Option	Description
Disabled	Set this value to prevent the serial port from accessing any system resources. When this option is set to <i>Disabled</i> , the serial port physically becomes unavailable.
3F8/IRQ4	Set this value to allow the serial port to use 3F8 as its I/O port address and IRQ4 for the interrupt address. This is the default setting. The majority of serial

port 1 or COM1 ports on computer systems use IRQ4 and I/O Port 3F8 as the standard setting. The most common serial device connected to this port is a mouse. If the system will not use a serial device, it is best to set this port to Disabled.

- **Serial Port2 Address**

This option specifies the base I/O port address and Interrupt Request address of serial port 2. The Optimal setting is 2F8/IRQ3.

Option	Description
Disabled	Set this value to prevent the serial port from accessing any system resources. When this option is set to <i>Disabled</i> , the serial port physically becomes unavailable.
2F8/IRQ3	Set this value to allow the serial port to use 2F8 as its I/O port address and IRQ 3 for the interrupt address. This is the default setting. The majority of serial port 2 or COM2 ports on computer systems use IRQ3 and I/O Port 2F8 as the standard setting. The most common serial device connected to this port is an external modem. If the system will not use an external modem, set this port to <i>Disabled</i> . Note: Most internal modems require the use of the second COM port and use 3F8 as its I/O port address and IRQ 4 for its interrupt address. This requires that the Serial Port2 Address be set to <i>Disabled</i> or another base I/O port address and Interrupt Request address.

- **Serial Port3 Address**

This option specifies the base I/O port address of serial port 3. The Optimal setting is 3E8.

- **Serial Port3 IRQ**

This option specifies the Interrupt Request address of serial port 3. The Optimal setting is 10.

Option	Description
Disabled	Set this value to prevent the serial port from accessing any system resources. When this option is set to <i>Disabled</i> , the serial port physically becomes unavailable.
3E8/IRQ10	Set this value to allow the serial port to use 3E8 as its I/O port address and IRQ10 for the interrupt address. This is the default setting. If the system will not use a serial device, it is best to set this port to Disabled.

- **Serial Port4 Address**

This option specifies the base I/O port address of serial port 4. The Optimal setting is 2E8.

- **Serial Port4 IRQ**

This option specifies the Interrupt Request address of serial port 4. The Optimal setting is 11.

Option	Description
Disabled	Set this value to prevent the serial port from accessing any system resources. When this option is set to <i>Disabled</i> , the serial port physically becomes unavailable.
2E8/IRQ11	Set this value to allow the serial port to use 2E8 as its I/O port address and IRQ11 for the interrupt address. This is the default setting. If the system will not use a serial device, it is best to set this port to Disabled.

- **Serial Port5 Address**

This option specifies the base I/O port address of serial port 5. The Optimal setting is 2E0.

- **Serial Port5 IRQ**

This option specifies the Interrupt Request address of serial port 5. The Optimal setting is 5.

Option	Description
Disabled	Set this value to prevent the serial port from accessing any system resources. When this option is set to <i>Disabled</i> , the serial port physically becomes unavailable.
2E0/IRQ5	Set this value to allow the serial port to use 2E0 as its I/O port address and IRQ5 for the interrupt address. This is the default setting. If the system will not use a serial device, it is best to set this port to Disabled.

You can use this screen to select options for the Hardware Health settings. Use the up and down <Arrow> keys to select an item. Use the <Plus> and <Minus> keys to change the value of the selected option. The settings are described on the following pages. The screen is shown below.

The screenshot shows a BIOS Setup Utility window titled "RMC@SERVER - Advanced Video Redirection" with a "Settings" subtitle. The main title is "BIOS SETUP UTILITY" and the current section is "Advanced".

Hardware Health Configuration		Options
Chassis Intrusion	[Disabled]	Disabled Enabled
System Temperature	:40°C/104°F	
CPU Temperature	:43°C/109°F	
SYS_FAN1 Speed	:0 RPM	
CPU_FAN1 Speed	:4687 RPM	
Ucore	:1.128 U	
AVCC	:3.296 U	
3VCC	:3.296 U	
+12V	:12.249 U	
5VUSB	:5.027 U	
+5V	:4.947 U	
+3.3V	:3.296 U	
VBAT	:3.232 U	
CPU Smart Fan	[Disabled]	
System Smart Fan	[Disabled]	

Options:

- < Left Arrow > Select Screen
- < Up/Down Arrow > Select Item
- < Plus/Minus > Change Option
- F1 General Help
- F10 Save and Exit
- ESC Exit

At the bottom, it says "v02.61 (C) Copyright 1985-2006, American Megatrends, Inc." Below the BIOS screen is a control bar with buttons for "Ctrl", "Alt", "Shift", "Send Key Sequence", a dropdown menu showing "Ctrl-Alt-Del", "Sync Mouse", and "Help". At the very bottom, it shows "AVR running - Video mode: 640x480 Graphic (43)" and "Language: US / US".

- **Chassis Intrusion**

This item selects the chassis intrusion. The choices are Disabled or Enabled.

- **System Temperature**

This shows you the current temperature of system.

- **CPU Temperature**

This shows you the current CPU temperature.

- **SYS_FAN Speed**

This shows the current System FAN operating speed.

- **CPU_FAN Speed**

This shows the current CPU FAN operating speed.

- **Vcore/ 3VCC/ +12V/ +5V/ 5VSB/ 3VSB/ VBAT**

This shows the voltage of VCORE, 3VCC, +12V, +5V, 5VSB(V), 3VSB(V) and VBAT(V).

- **CPU Smart Fan**

The options are **Disabled, Silent mode, Optimal mode and Performance mode.**

- **System Smart Fan**

The options are **Disabled, Silent mode, Optimal mode and Performance mode.**

2.4.2 ACPI Configuration

You can use this screen to select options for the ACPI settings. Use the up and down <Arrow> keys to select an item. Use the <Plus> and <Minus> keys to change the value of the selected option. The settings are described on the following pages. The screen is shown below.



- **General ACPI Configuration**

This item allows you to set general ACPI Configuration.

- **Chipset ACPI Configuration**

This item allows you to set South Bridge ACPI Configuration.

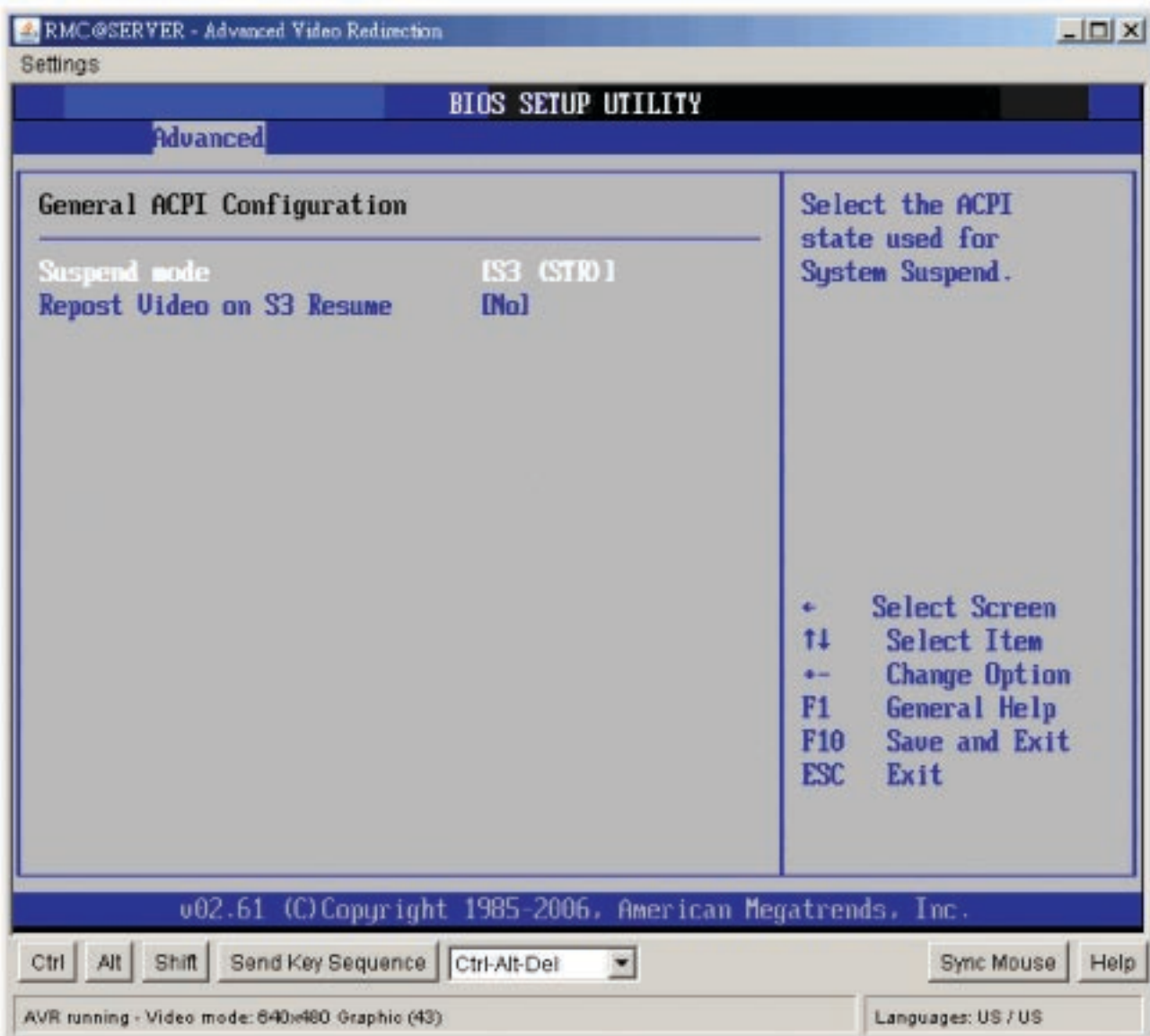

- **Suspend mode**

The item allows you to select the suspend type under the ACPI operating system.

Option	Description
S1 (POS)	Power on Suspend
S3 (STR)	Suspend to RAM
Auto	POS+STR

- **Repost Video on S3 Resume**

Determines whether to invoke VGA BIOS post on S3/STR resume. The choices are No or Yes.

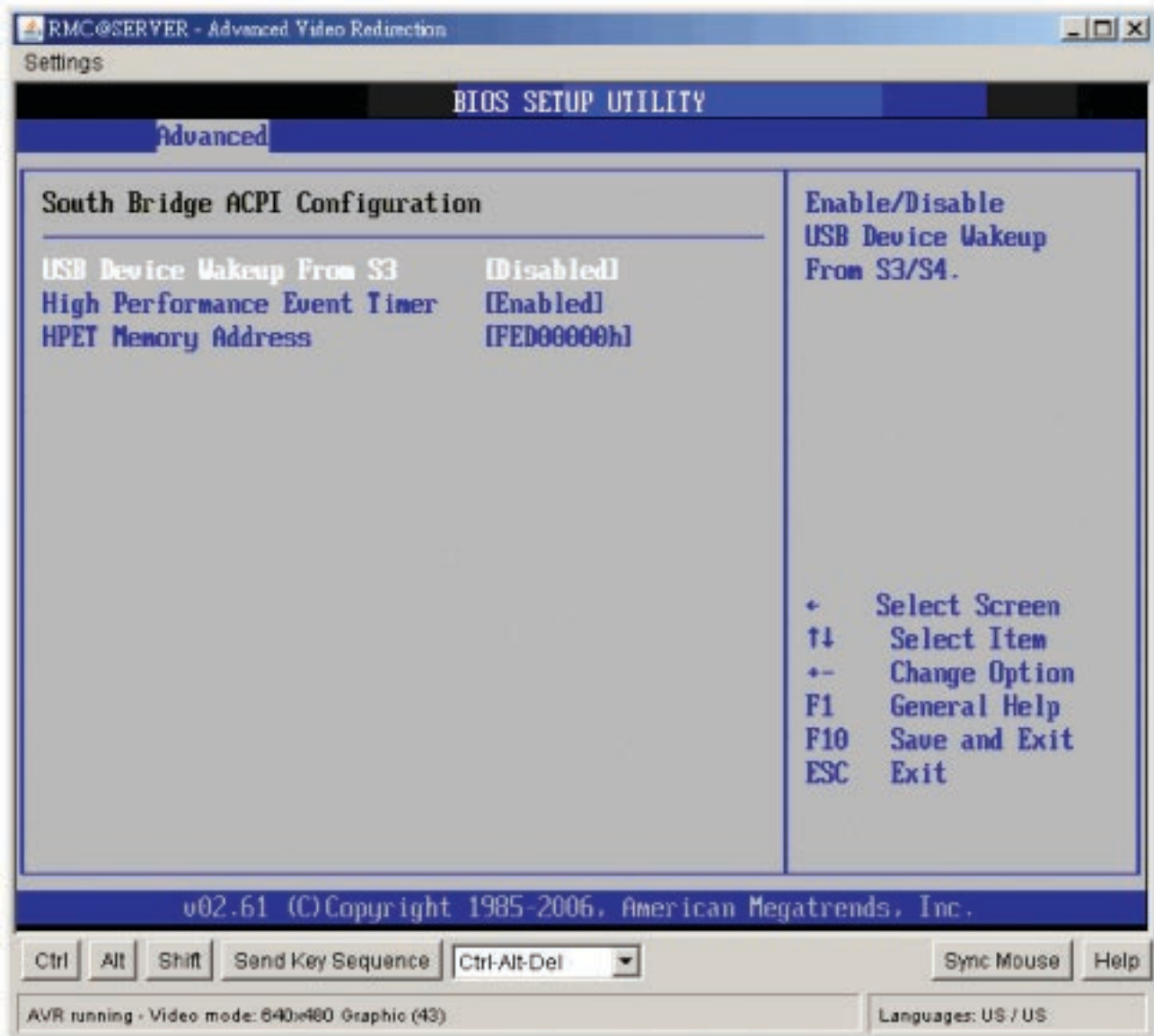

- **USB Device Wakeup from S3**

This item allows you to enable or disabled the USB resume from S3/S4 status.

- **High Performance Event Timer**

This item allows you to enable or disable the High Performance Event Timer.

- **HPET Memory Address**

This item allows you to allot the Event Timer Block Registers Base Address to thememory.

2.4.3 AHCI Configuration

You can use this screen to select options for the AHCI settings. Use the up and down <Arrow> keys to select an item. Use the <Plus> and <Minus> keys to change the value of the selected option. The settings are described on the following pages. The screen is shown below.

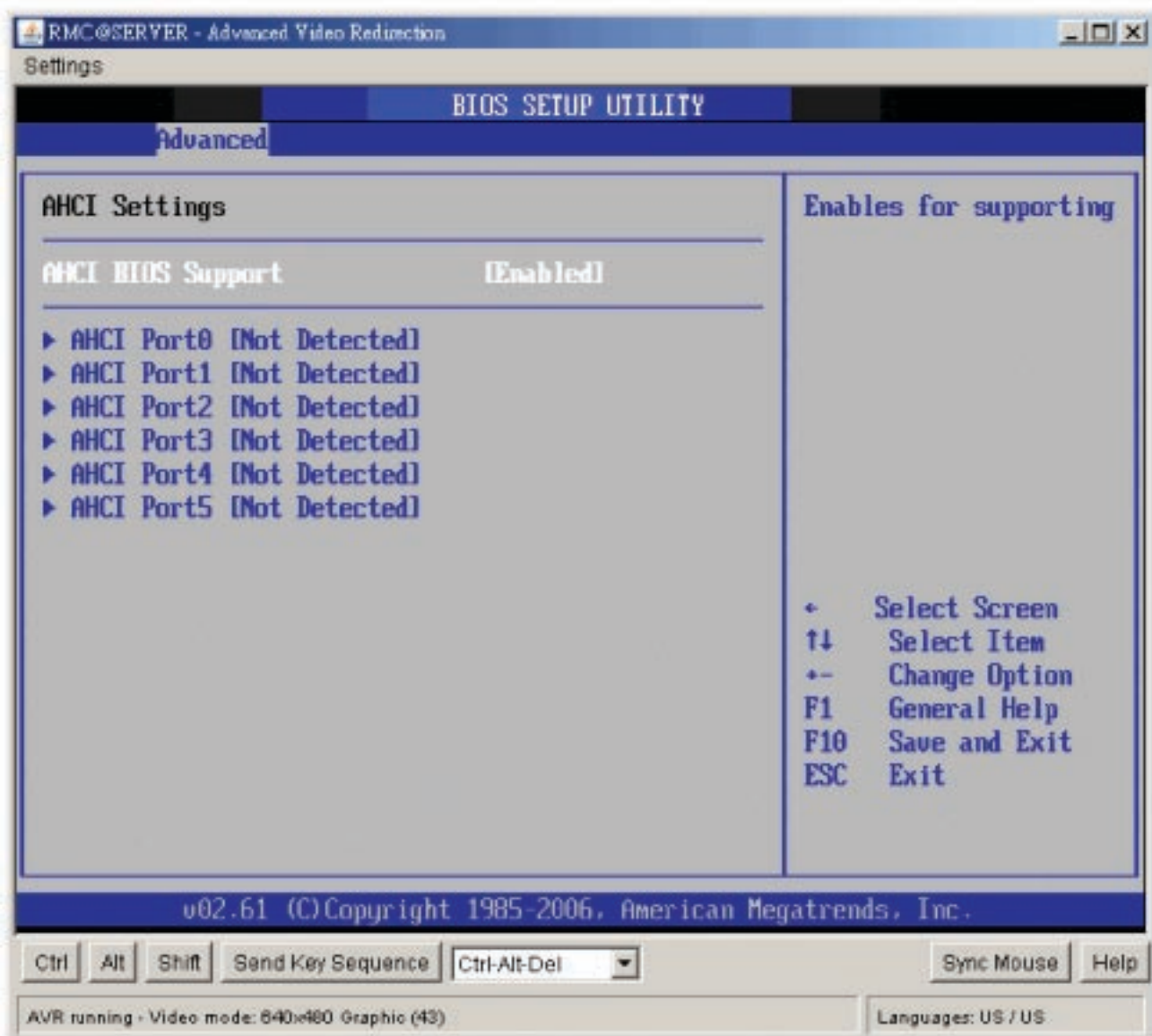

- **AHCI BIOS Support**

This BIOS feature controls the AHCI function of SATA controller. The choice are Enabled (Default) / Disabled

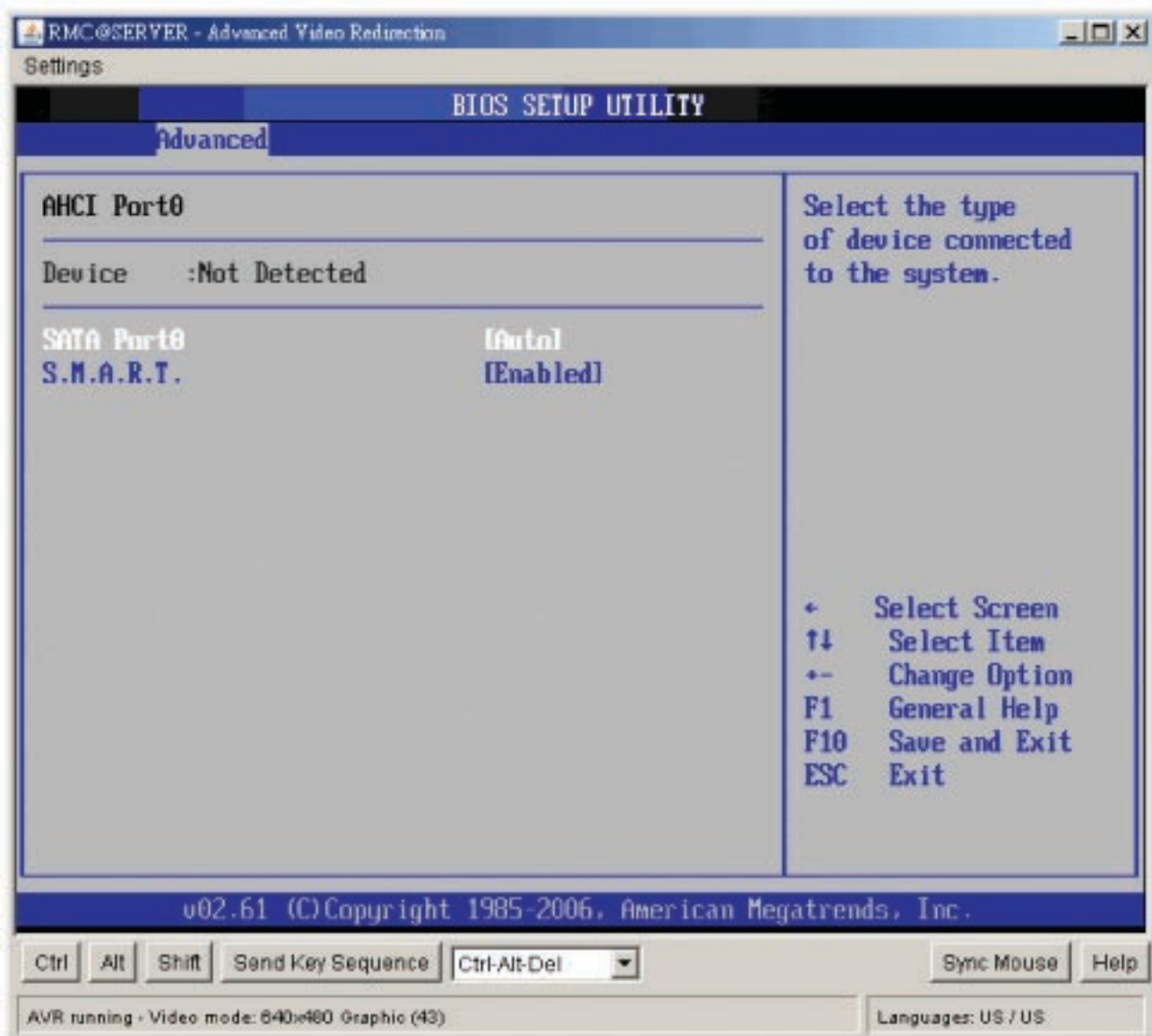

- **Device**

This area shows the detected connected device.

- **SATA Port0/1/2/3/4/5**

This item allows you to select the connected device type. Options: Auto (Default)

- **S.M.A.R.T.**

This item allows you to control the device S.M.A.R.T function. The options are Enabled (Default) / Disabled

2.4.4 APM Configuration

You can use this screen to select options for the APM settings. Use the up and down <Arrow> keys to select an item. Use the <Plus> and <Minus> keys to change the value of the selected option. The settings are described on the following pages.

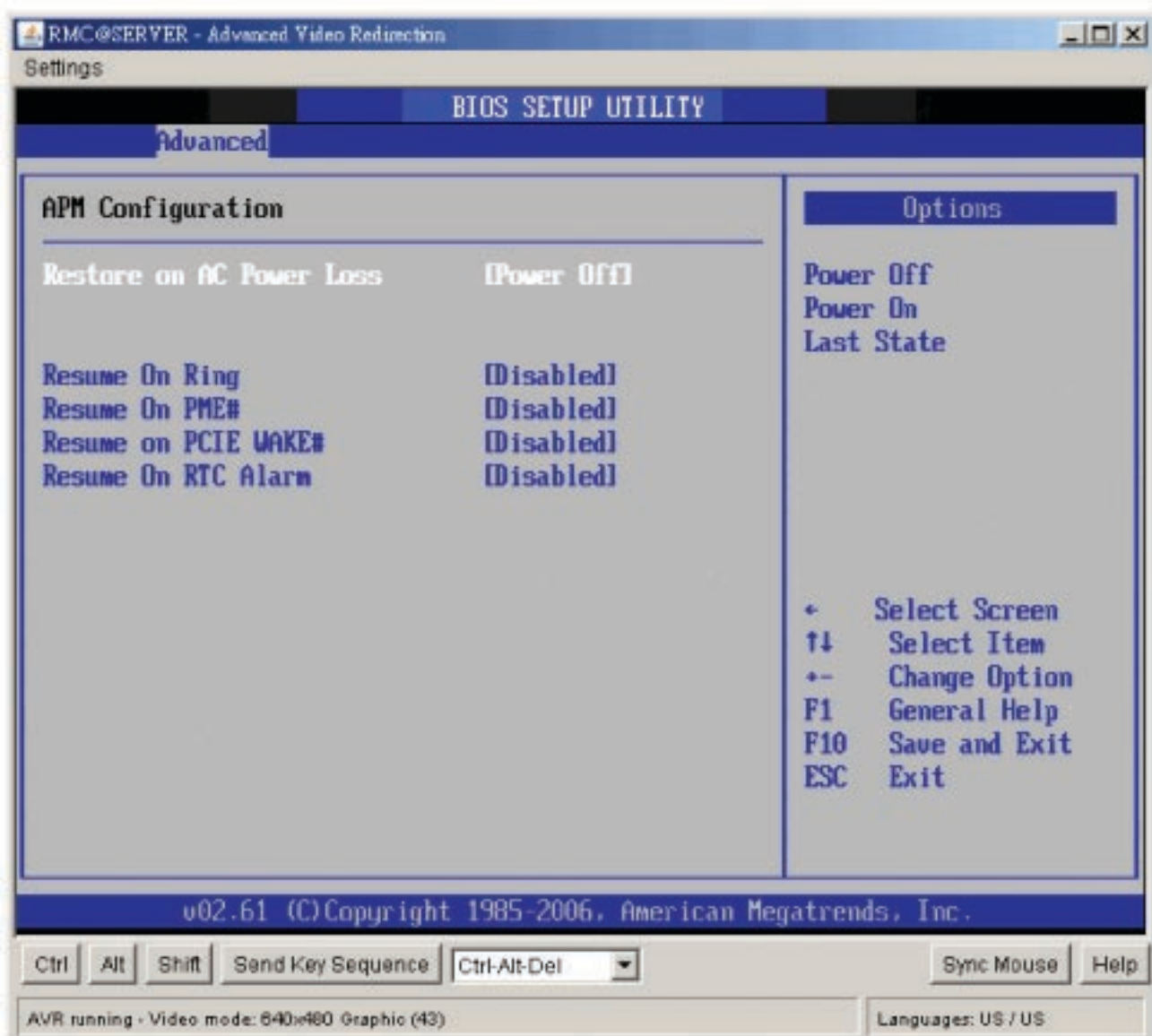

- **Restore on AC Power Loss**

This item allows you to set AC Power Loss to Power Off, Power On, or Last State.

- **Resume On Ring**

Disable or Enable RI to generate a wake event.

- **Resume On PME#**

Disable or Enable PME to generate a wake event.

- **Resume On PCIE WAKE#**

Disable or Enable PCIE generate a wake event.

- **Resume RTC Alarm**

Disable or Enable RTC to generate a wake event.

2.4.5 Intel AMT Configuration

You can use this screen to select options for Intel AMT settings. Use the up and down <Arrow> keys to select an item. Use the <Plus> and <Minus> keys to change the value of the selected option. The settings are described on the following pages.

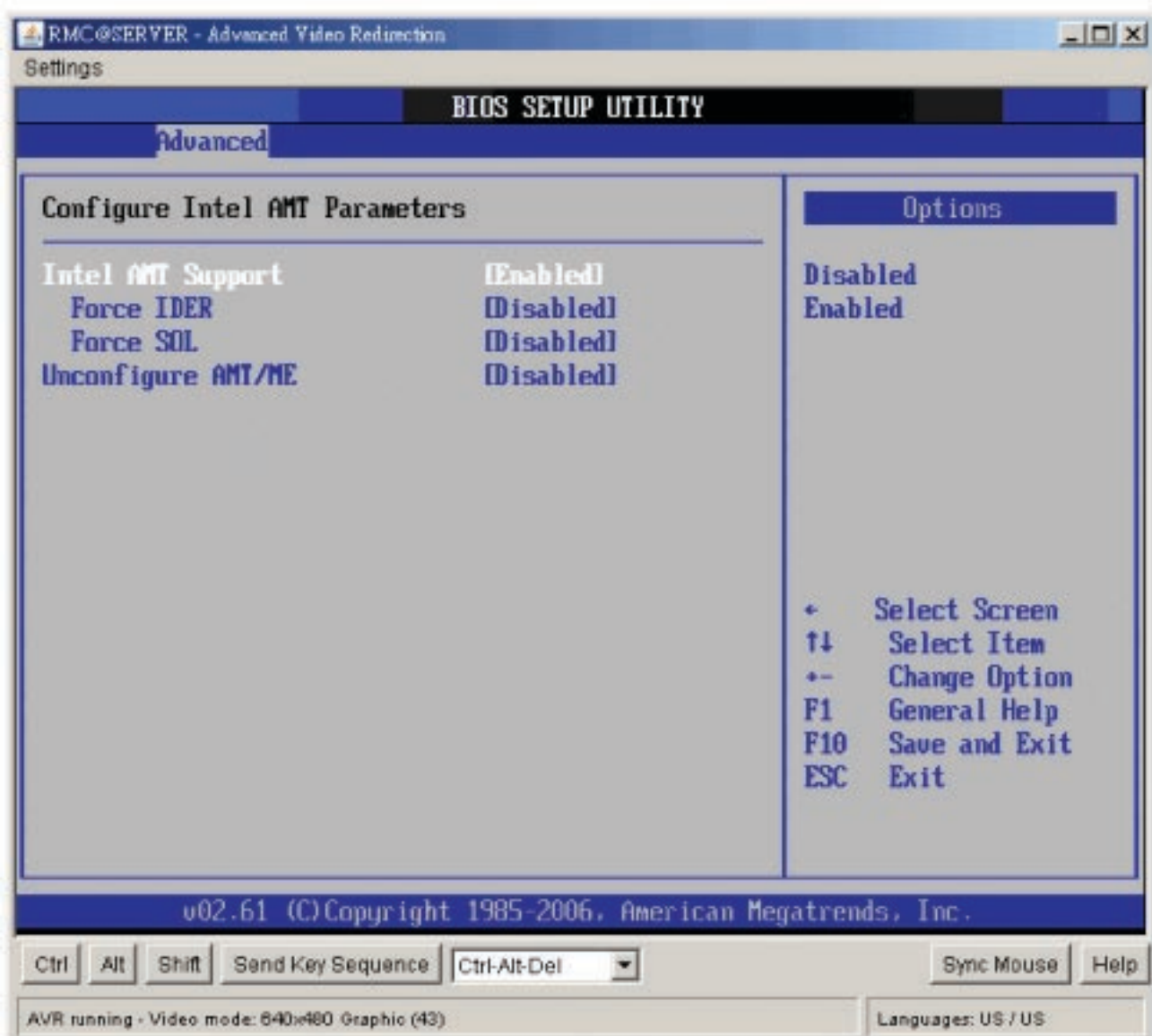

● Intel AMT Support

Intel Active Management Technology (AMT) is hardware-based technology for remotely managing and securing PCs out-of-band. The options are Disabled, Enabled

● Force IDE/Force SOL

SOL/ IDER (Serial Over LAN/ IDE-Redirection) is a protocol defined for Intel Active Management Technology that allows redirecting the keyboard/text or floppy disk/CD transfers from a local host to a remote workstation.

● Unconfigure AMT/ME

To finish the unconfiguration of AMT, set this setting to [Enabled] and the BIOS will unconfigure all of AMT/ME settings and all the passwords are reset.

2.4.6 Intel TXT (LT) Configuration

You can use this screen to select options for the Intel TXT (LT) settings. Use the up and down <Arrow> keys to select an item. Use the <Plus> and <Minus> keys to change the value of the selected option. The settings are described on the following pages. The screen is shown below.

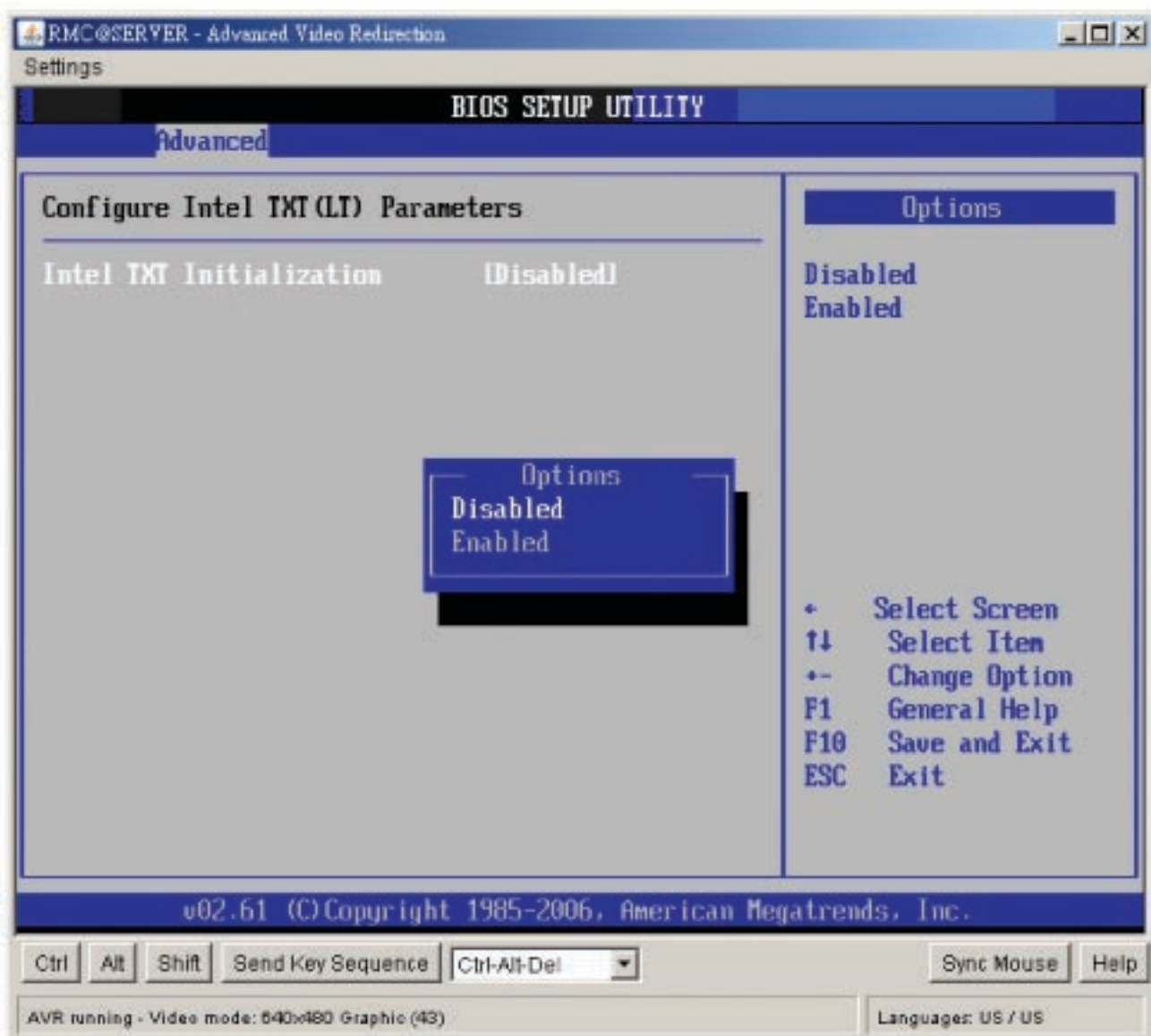

- **Intel TXT Initialization**

The Choices are enabled or disabled the Intel TXT initialization.

2.4.7 Intel VT-d Configuration

You can use this screen to select options for the Intel VT-d settings. Use the up and down <Arrow> keys to select an item. Use the <Plus> and <Minus> keys to change the value of the selected option. The settings are described on the following pages. The screen is shown below.

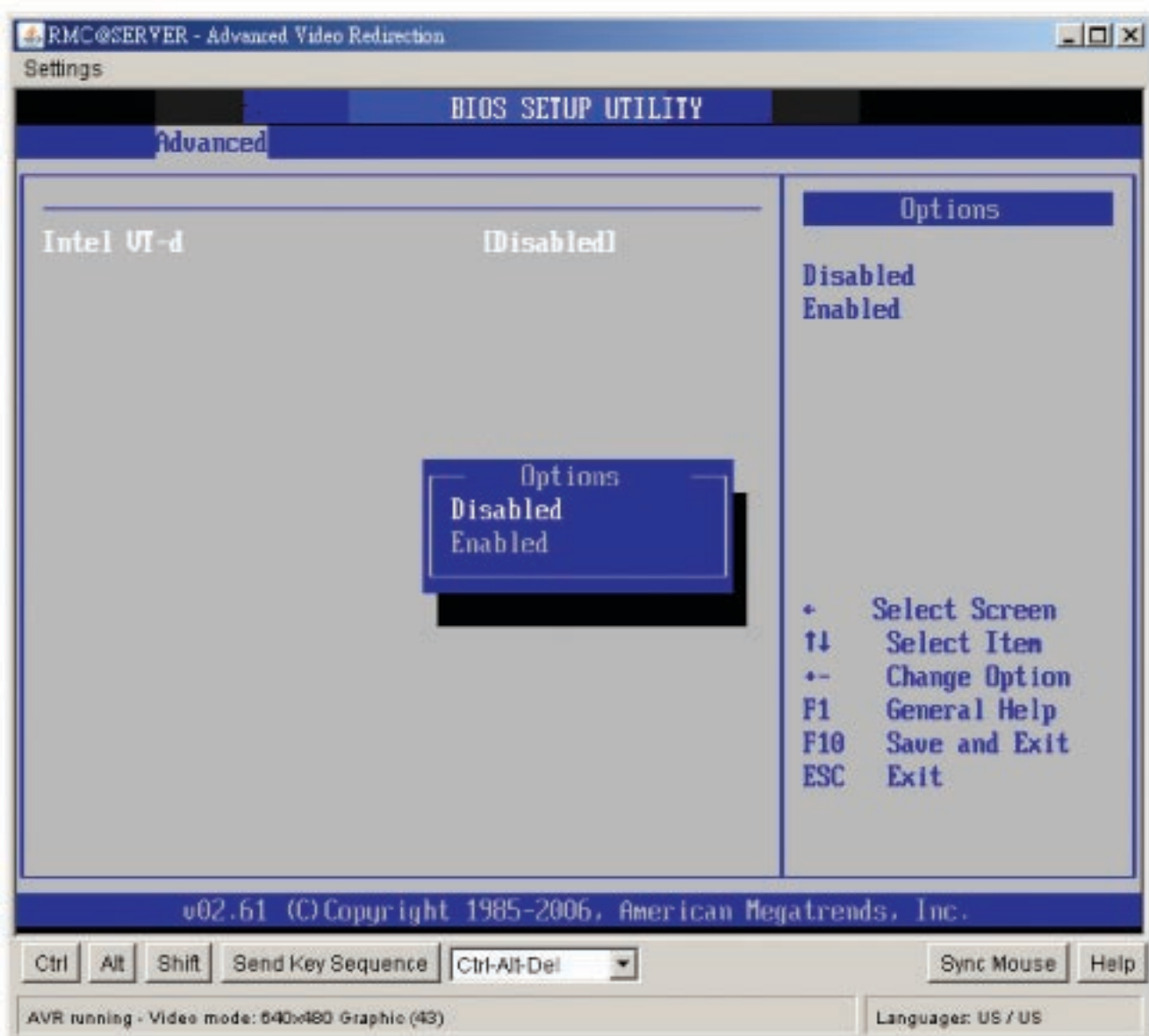

• Intel VT-d

The Choices are enabled or disabled the Intel VT-d.

2.4.8 Trusted Computing

You can use this screen to select options for the Intel Trusted Computing settings. Use the up and down <Arrow> keys to select an item. Use the <Plus> and <Minus> keys to change the value of the selected option. The settings are described on the following pages. The screen is shown below.



• TCG/TPM SUPPORT

Enable or disable TPM TCG (TPM 1.1/1.2) support in BIOS.

2.5 Advanced PCI/PnP Settings

Select the *PCI/PnP* tab from the setup screen to enter the Plug and Play BIOS Setup screen. You can display a Plug and Play BIOS Setup option by highlighting it using the <Arrow> keys. All Plug and Play BIOS Setup options are described in this section. The Plug and Play BIOS Setup screen is shown below.

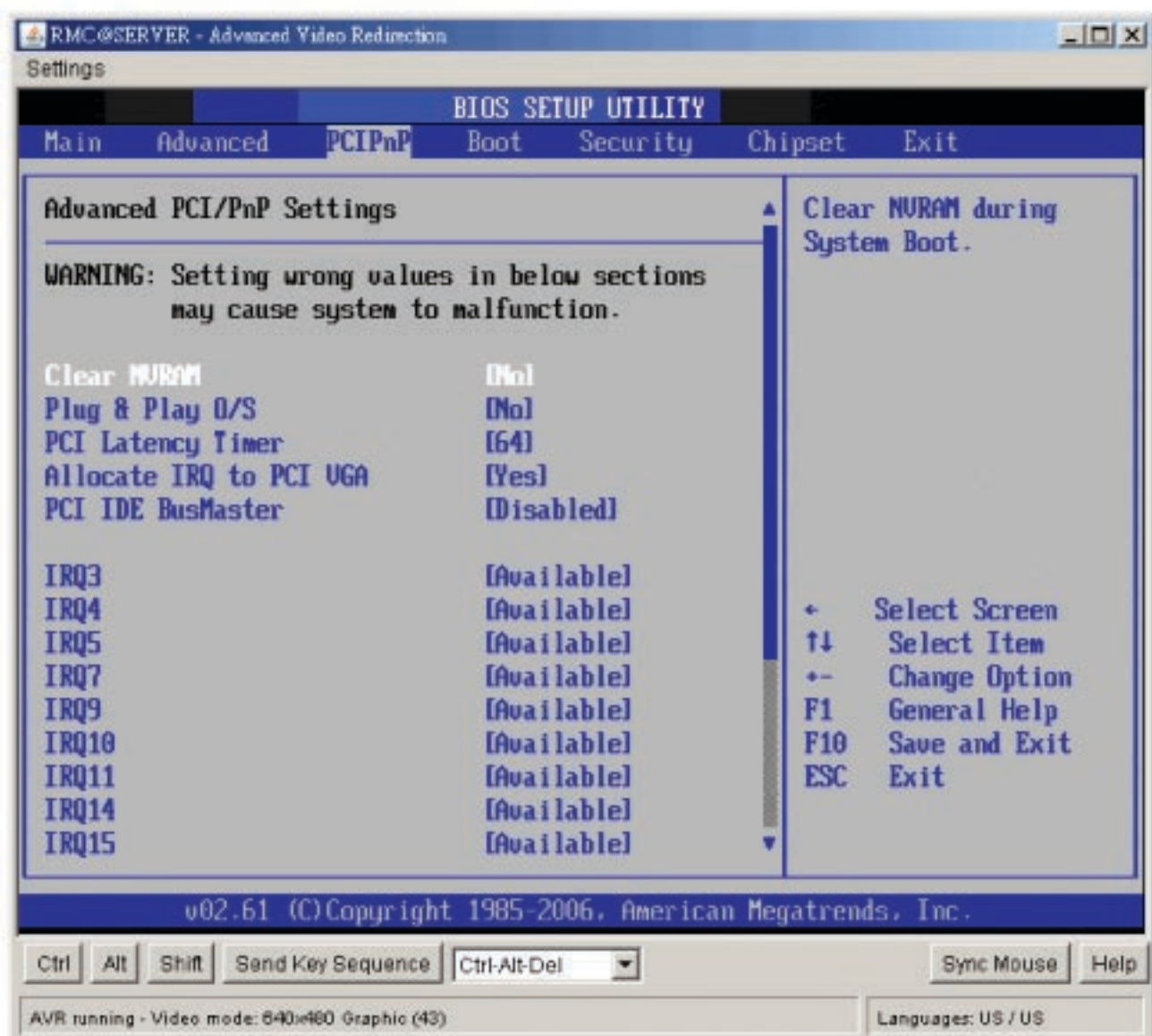

2.5.1 Clear NVRAM

This item is to clear NVRAM during system boot. The choices are No or Yes.

2.5.2 Plug & Play O/S

Set this value to allow the system to modify the settings for Plug and Play operating system support. The default setting is No.

Option	Description
No	The No setting is for operating systems that do not meet the Plug and Play specifications. It allows the BIOS to configure all the devices in the system. This is the default setting.
Yes	The Yes setting allows the operating system to change the interrupt, I/O and DMA settings. Set this option if the system is running Plug and Play aware operating systems.

2.5.3 PCI Latency Timer

Set this value to allow the PCI Latency Timer to be adjusted. This option sets the latency of all PCI devices on the PCI bus. The default setting is 64.

Option	Description
32	This option sets the PCI latency to 32 PCI clock cycles.
64	This option sets the PCI latency to 64 PCI clock cycles. This is the default setting.
96	This option sets the PCI latency to 96 PCI clock cycles.
128	This option sets the PCI latency to 128 PCI clock cycles.
160	This option sets the PCI latency to 160 PCI clock cycles.
192	This option sets the PCI latency to 192 PCI clock cycles.
224	This option sets the PCI latency to 224 PCI clock cycles.
248	This option sets the PCI latency to 248 PCI clock cycles.

2.5.4 Allocate IRQ to PCI VGA

Set this value to allow or restrict the system from giving the VGA adapter card an interrupt address. The default setting is Yes.

Option	Description
Yes	Set this value to allow the allocation of an IRQ to a VGA adapter card that uses the PCI local bus. This is the default setting.
No	Set this value to prevent the allocation of an IRQ to a VGA adapter card that uses the PCI local bus.

2.5.5 PCI IDE BusMaster

Set this value to allow or prevent the use of PCI IDE busmastering. The setting is Disabled.

Option	Description
Disabled	Set this value to prevent PCI busmastering. This is the default setting.
Enabled	This option specifies that the IDE controller on the PCI local bus has mastering capabilities.

2.5.6 IRQ

Set this value to allow the IRQ settings to be modified. The default setting is available.

Interrupt	Option	Description
IRQ3 IRQ4 IRQ5 IRQ7 IRQ9	Available	This setting allows the specified IRQ to be used by a PCI/PnP device. This is the default setting.
IRQ10 IRQ11 IRQ14 IRQ15	Reserved	This setting allows the specified IRQ to be used by a legacy ISA device.

2.5.7 DMA

Set this value to allow the DMA setting to be modified. The default setting is Available.

DMA Channel	Option	Description
DMA Channel 0 DMA Channel 1 DMA Channel 3 DMA Channel 5	Available	This setting allows the specified DMA to be used by PCI/PnP device. This is the default setting.
DMA Channel 6 DMA Channel 7	Reserved	This setting allows the specified DMA to be used by a legacy ISA device.

2.6 Boot Setting Configuration

Select the *Boot* tab from the setup screen to enter the Boot Setup screen. You can display a Boot Setup option by highlighting it using the <Arrow> keys. All Boot BIOS Setup options

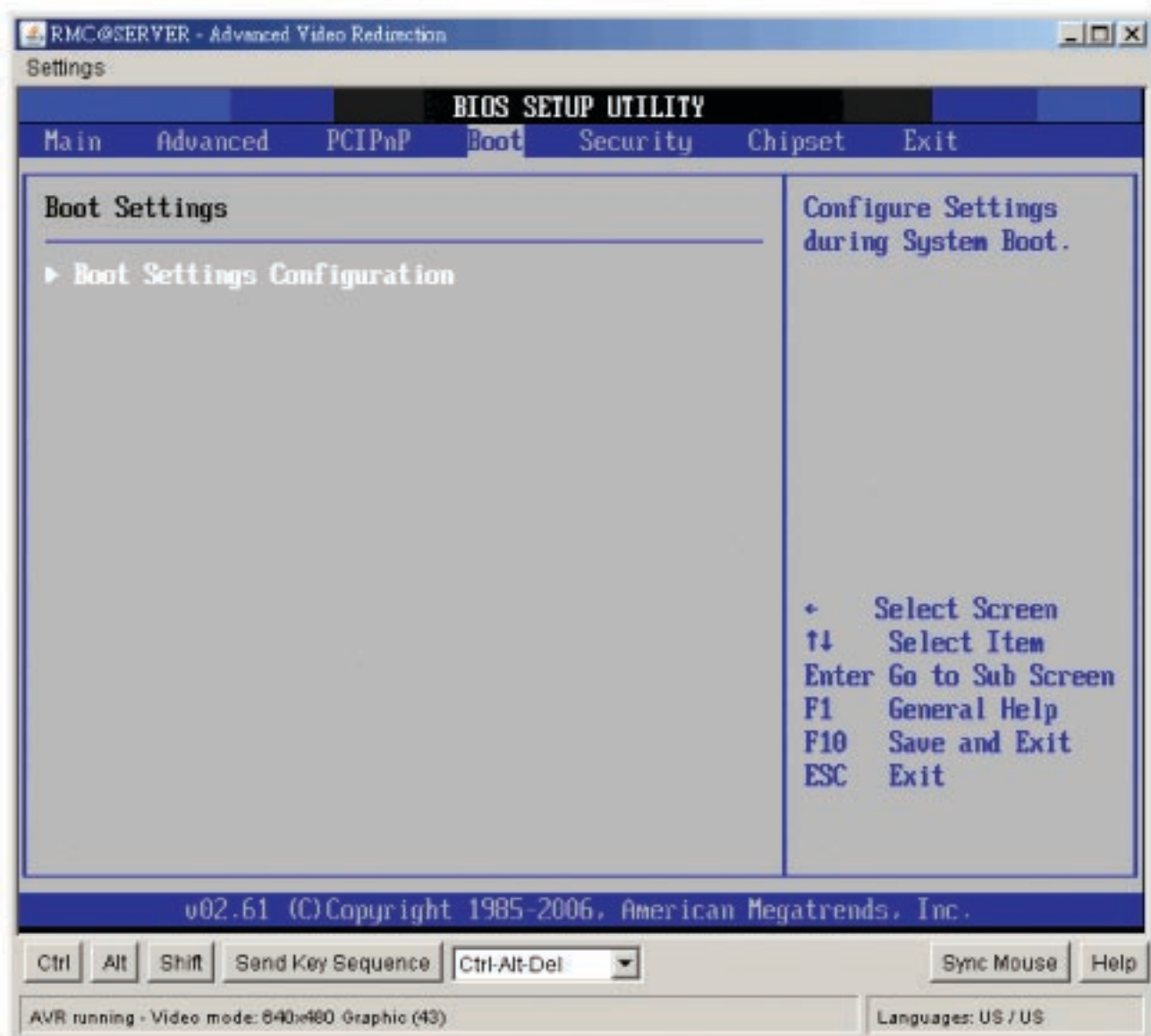

are described in this section. The Boot BIOS Setup screen is shown below.

2.6.1 Boot Settings Configuration

You can use this screen to select options for the Boot settings. Use the up and down <Arrow> keys to select an item. Use the <Plus> and <Minus> keys to change the value of the selected option. The settings are described on the following pages. The screen is shown below.

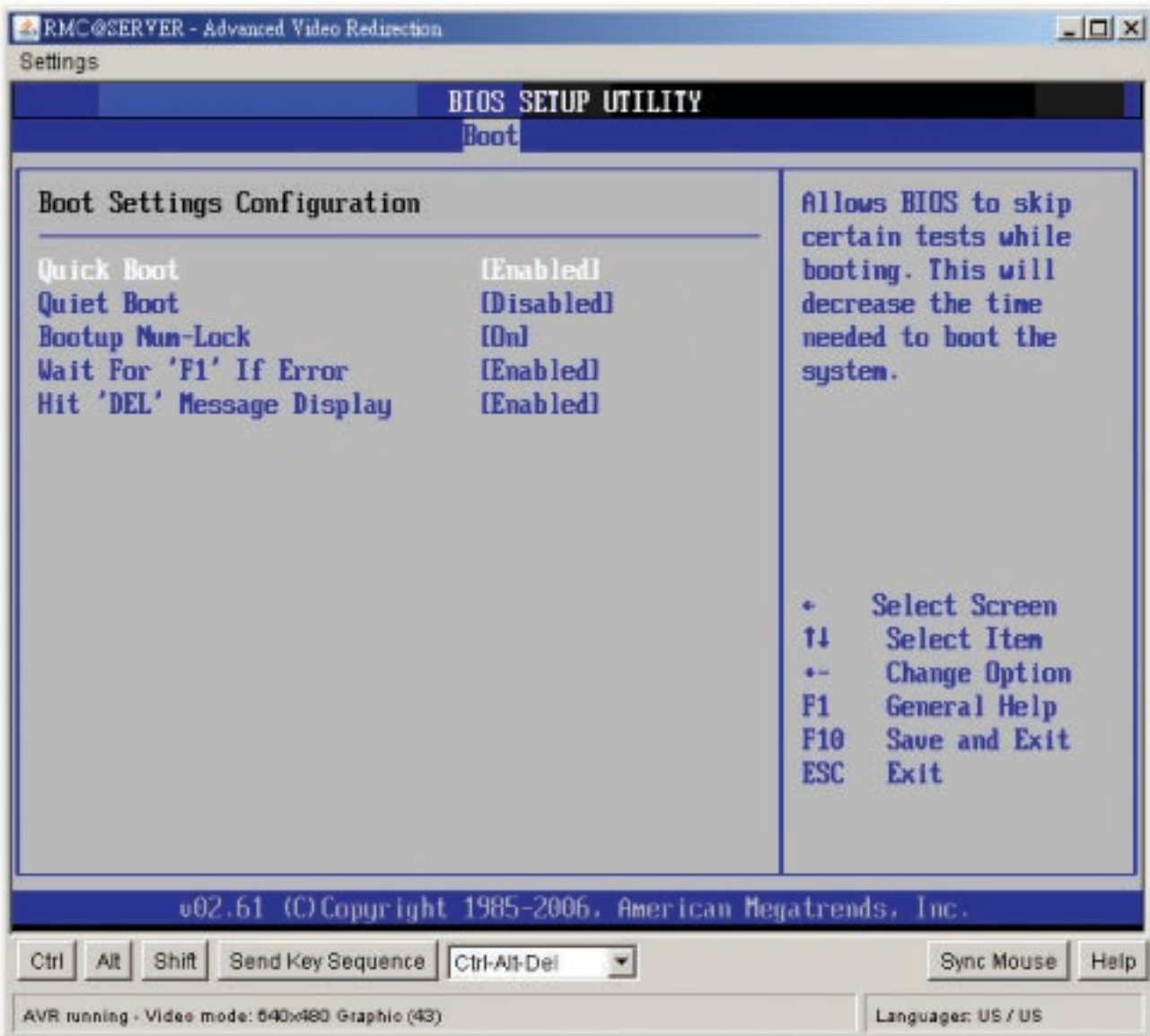

- **Quick Boot**

The default setting is Enabled.

Option	Description
Disabled	Set this value to allow the BIOS to perform all POST tests.
Enabled	Set this value to allow the BIOS to skip certain POST tests to boot faster.

- **Quiet Boot**

Set this value to allow the boot up screen options to be modified between POST messages or OEM logo. The default setting is Disabled.

Option	Description
Disabled	Set this value to allow the computer system to display the POST messages.
Enabled	Set this value to allow the computer system to display the OEM logo. This is the default setting.

- **Bootup Num-Lock**

Set this value to allow the Number Lock setting to be modified during boot up. The default setting is On.

Option	Description
Off	This option does not enable the keyboard Number Lock automatically. To use the 10-keys on the keyboard, press the Number Lock key located on the upper left-hand corner of the 10-key pad. The Number Lock LED on the keyboard will light up when the Number Lock is engaged.
On	Set this value to allow the Number Lock on the keyboard to be enabled automatically when the computer system is boot up. This allows the immediate use of 10-keys numeric keypad located on the right side of the keyboard. To confirm this, the Number Lock LED light on the keyboard will be lit. This is the default setting.

- **Wait For "F1" If Error**

Set this value to allow the Wait for "F1" Error setting to be modified. The default setting is Enabled.

Option	Description
Disabled	This prevents the to wait on an error for user intervention. This setting should be used if there is a known reason for a BIOS error to appear. An example would be a system administrator must remote boot the system. The computer system does not have a keyboard currently attached. If this setting is set, the system will continue to boot up in to the operating system. If "F1" is enabled, the system will wait until the BIOS setup is entered.
Enabled	Set this value to allow the system BIOS to wait for any error. If an error is detected, pressing <F1> will enter Setup and the BIOS setting can be adjusted to fix the problem. This normally happens when upgrading the hardware and not setting the BIOS to recognized it. This is the default setting.

- **Hit "DEL" Message Display**

Set this value to allow the Hit "DEL" to enter Setup Message Display to be modified. The default setting is Enabled.

Option	Description
Disabled	This prevents to display "Hit Del to Enter Setup" during memory initialization. If Quiet Boot is enabled, the message will not display.
Enabled	This allows to display "Hit Del to Enter Setup" during memory initialization. This is the default setting.

2.7 Security Setup

Select Security Setup from the Setup main BIOS setup menu. All Security Setup options, such as password protection and virus protection, are described in this section. To access the sub menu for the following items, select the item and press <Enter>:

- Change Supervisor Password

The Security Setup screen is shown below. The sub menus are documented on the following pages.

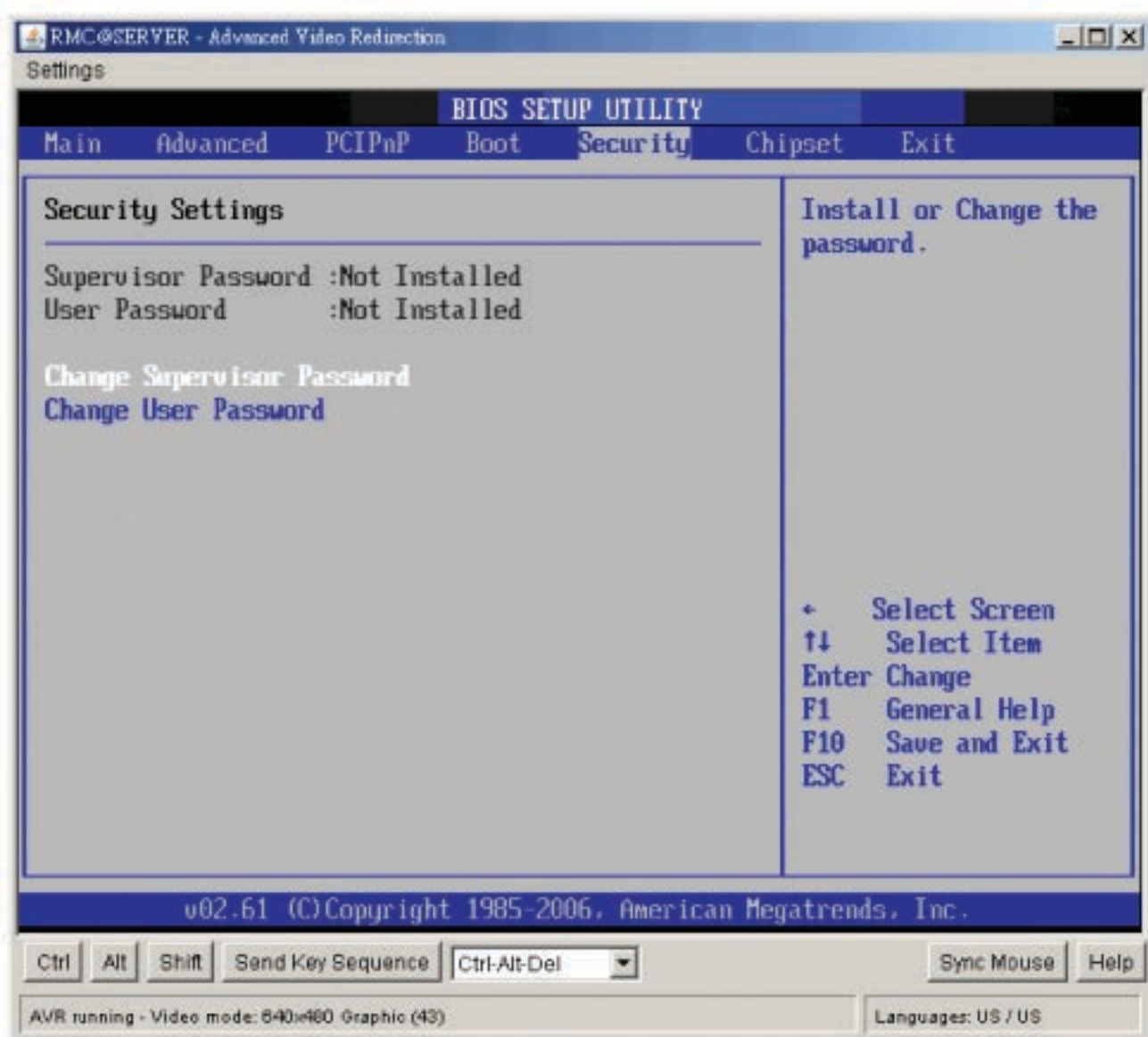

2.7.1 Change Supervisor Password

This item indicates whether a supervisor password has been set. If the password has been installed, *Installed* displays. If not, *Not Installed* displays.

2.7.2 Change User Password

This item indicates whether a user password has been set. If the password has been installed, *Installed* displays. If not, *Not Installed* displays.

2.8 Chipset Setup

Select the *Chipset* tab from the setup screen to enter the Chipset BIOS Setup screen. You can select any of the items in the left frame of the screen, such as CPU Configuration, to go to the sub menu for that item. You can display a Chipset BIOS Setup option by highlighting it using the <Arrow> keys. All Chipset BIOS Setup options are described in this section.

The Chipset BIOS Setup screen is shown below.

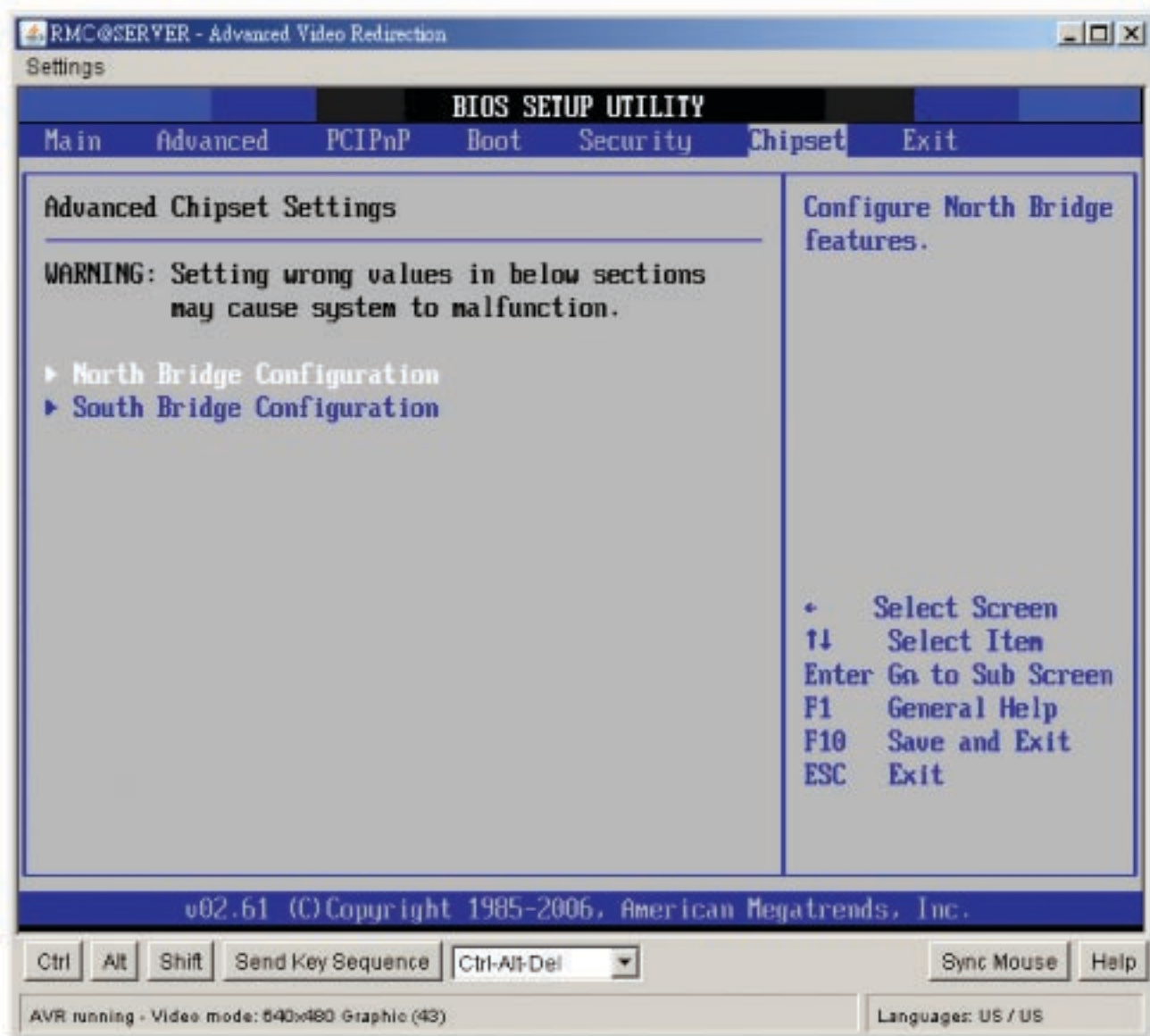

2.8.1 North Bridge Configuration

You can use this screen to select options for the North Bridge Configuration. Use the up and down <Arrow> keys to select an item. Use the <Plus> and <Minus> keys to change the value of the selected option.



Note: The North Bridge Configuration setup screen varies depending on the supported North Bridge chipset.

- **Boots Graphics Adaptor Priority**

This item selects which graphics controller to use as the primary boot device. The options are IGD, PCI/IGD, PCI/PEG, PEG/IGD, PEG/PCI. The default setting is PEG/PCI.

- **Internal Graphics Mode Select**

This item selects the amount of system memory used by the internal graphics device. The choices are Disabled, Enabled 32MB, Enabled 64MB, and Enabled 128MB.

• Video Function Configuration

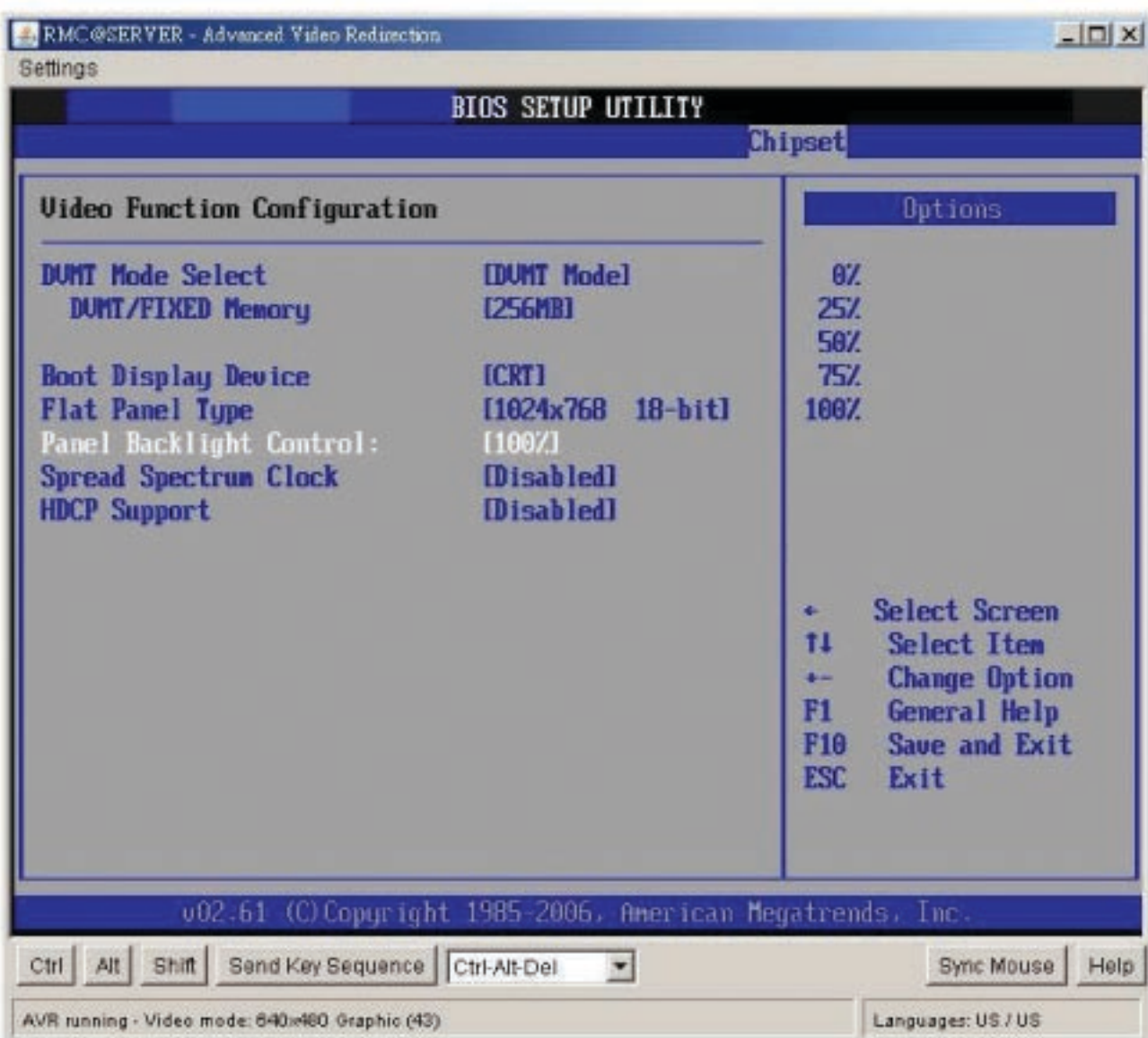

• DVMT Mode Select

Use this field to select the memory to allocate for video memory. The choice is "DVMT".

- DVMT/Fixed Memory Size

Specify the size of DVMT/system memory to allocate for video memory. The options are 128MB, 256MB and Maximum DVMT.

• Boot Display Device

Use the field to select the type of device you want to use as the display(s) of the system.

• Flat Panel Type

This setting allows you to set your preferences for the boot display device.

- **Panel Backlight Control**

This setting allows you to adjust the output of JBKL1 connector for LCD Panel's brightness. The choices are 0%, 25%, 50% and 100%. Notice: The change of LCD brightness might not be linear.

- **Spread Spectrum**

This setting allows you to reduce EMI by modulating the signals the CPU generates so that the spikes are reduced to flatter curves. This is achieved by varying the frequency slightly so that the signal does not use any particular frequency for more than a moment. The options: Disabled and Enabled.

- **HDCP Support**

HDCP(High-Bandwidth Digital Content Protection) is a copy protection protocol that was designed by Intel to prevent copying protected media as it travels across data lines. The choice are Disabled and Enabled.

2.8.2 South Bridge Configuration

You can use this screen to select options for the South Bridge Configuration. South Bridge is a chipset on the motherboard that controls the basic I/O functions, USB ports, audio functions, modem functions, IDE channels, and PCI slots. Use the up and down <Arrow> keys to select an item. Use the <Plus> and <Minus> keys to change the value of the selected option.

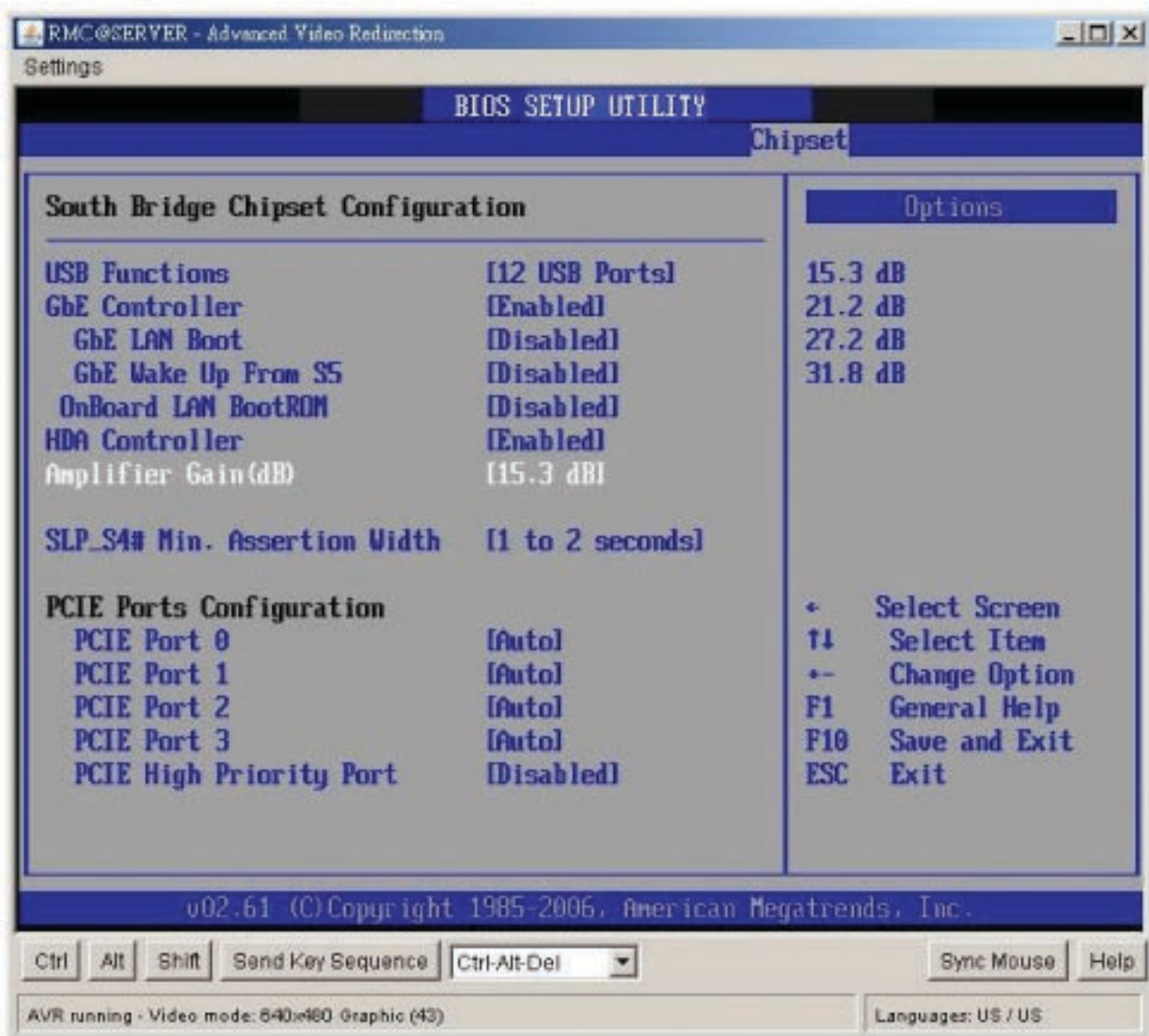

- **USB Functions**

Set this value to allow the system to enable or disable the onboard USB ports. The choices are Disabled, 2 USB Ports, 4 USB Ports, 6 USB Ports, 8 USB Ports, 10 USB Ports, 12 USB Ports.

- **GbE Controller**

Options are "Enabled" and "Disabled". Select "Disabled" if you don't want to use onboard

LAN controller.

- **GbE LAN Boot**

When [Enabled], the BIOS attempts to boot from a LAN boot image before it attempts to boot from a local storage device.

- **GbE Wake up From S5**

This field specifies whether the system will be awakened from the S5 power saving mode when activity or input signal of onboard LAN is detected.

- **OnBoard LAN Boot ROM**

Options are "Enabled" and "Disabled". Select "Disabled" if you don't want to use onboard LAN Boot Rom.

- **HDA Controller**

Options are "Enabled" and "Disabled". Select "Disabled" if you don't want to use HDA controller.

- **Amplifier Gain(dB)**

Options are "15.3 dB", "21.2 dB", "27.2 dB" and "31.8 dB".

- **SLP_S4# Min. Assertion Width**

The choices are 4 to 5 seconds, 3 to 4 seconds, 2 to 3 seconds, and 1 to 2 seconds.

- **PCIE Ports Configuration**

Option	Description
PCIE Port 0	This setting allows to enable the PCIE Port 0. The choices are Auto, Enabled, and Disabled.
PCIE Port 1	This setting allows to enable the PCIE Port 1. The choices are Auto, Enabled, and Disabled.
PCIE Port 2	This setting allows to enable the PCIE Port 2. The choices are Auto, Enabled, and Disabled.
PCIE Port 3	This setting allows to enable the PCIE Port 3. The choices are Auto, Enabled, and Disabled.
PCIE High Priority Port	This setting allows to select the PCIE High Priority Port. The choices are Disabled, Port 0, Port 1, Port 2 and Port 3.

2.9 Exit Menu

Select the *Exit* tab from the setup screen to enter the Exit BIOS Setup screen. You can display an Exit BIOS Setup option by highlighting it using the <Arrow> keys. All Exit BIOS Setup options are described in this section. The Exit BIOS Setup screen is shown below.

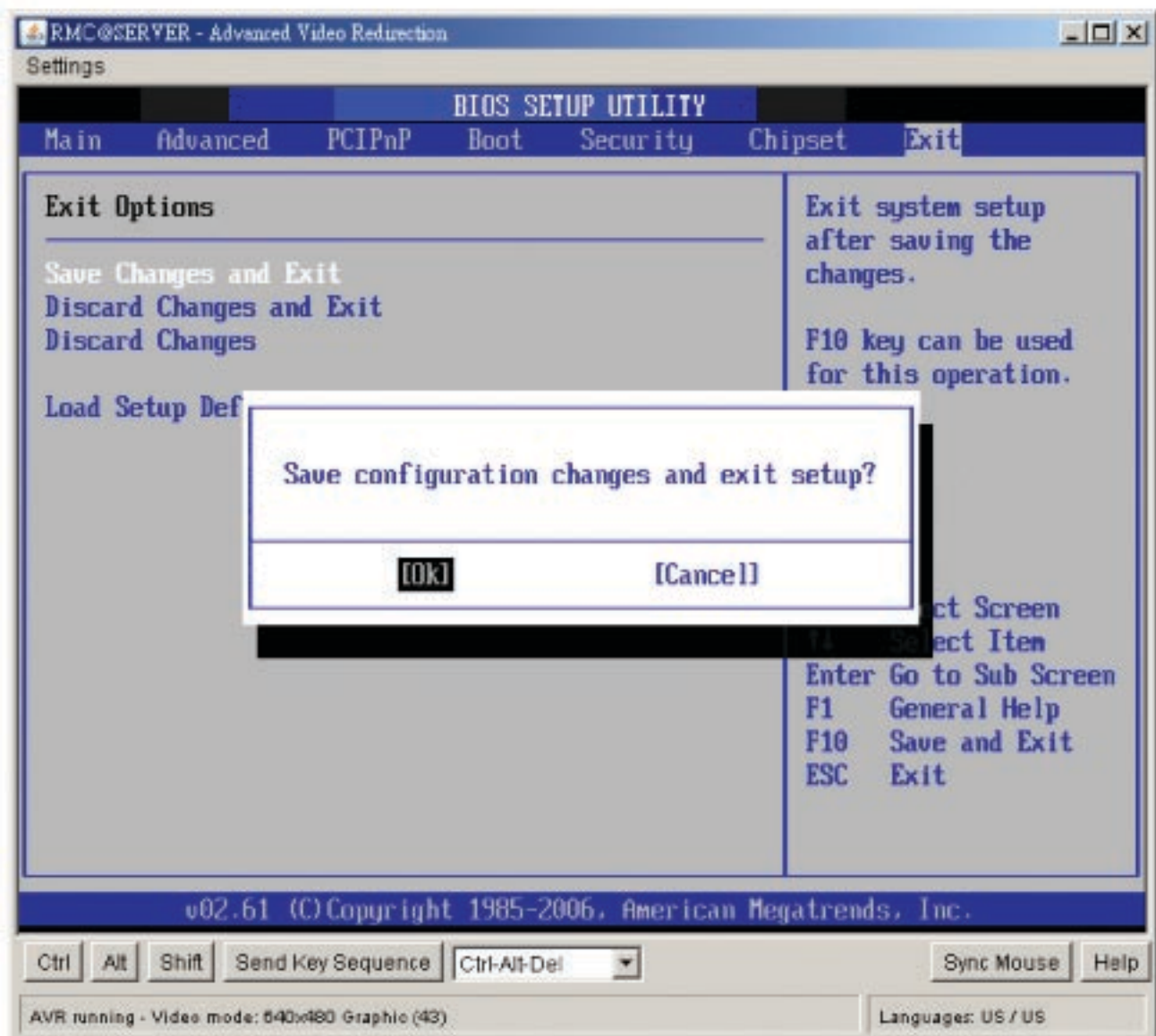

2.9.1 Save Changes and Exit

When you have completed the system configuration changes, select this option to leave

Setup and reboot the computer so the new system configuration parameters can take effect. Select Exit Saving Changes from the Exit menu and press <Enter>.

Save Configuration Changes and Exit Now?

[Ok] [Cancel]

appears in the window. Select Ok to save changes and exit.

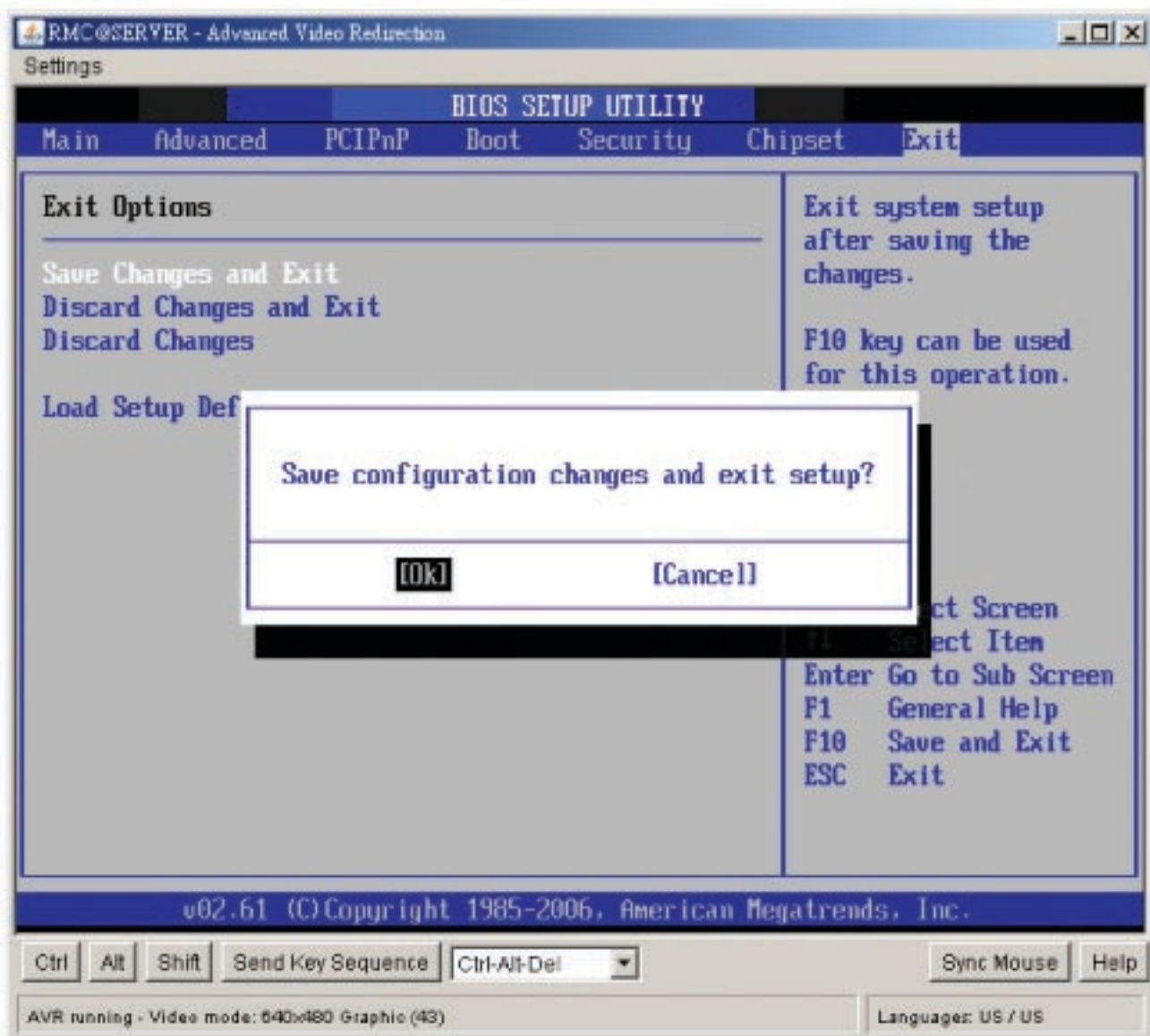

2.9.2 Discard Changes and Exit

Select this option to quit Setup without making any permanent changes to the system configuration. Select Exit Discarding Changes from the Exit menu and press <Enter>.

Discard Changes and Exit Setup Now?

[Ok] [Cancel]

appears in the window. Select *Ok* to discard changes and exit.

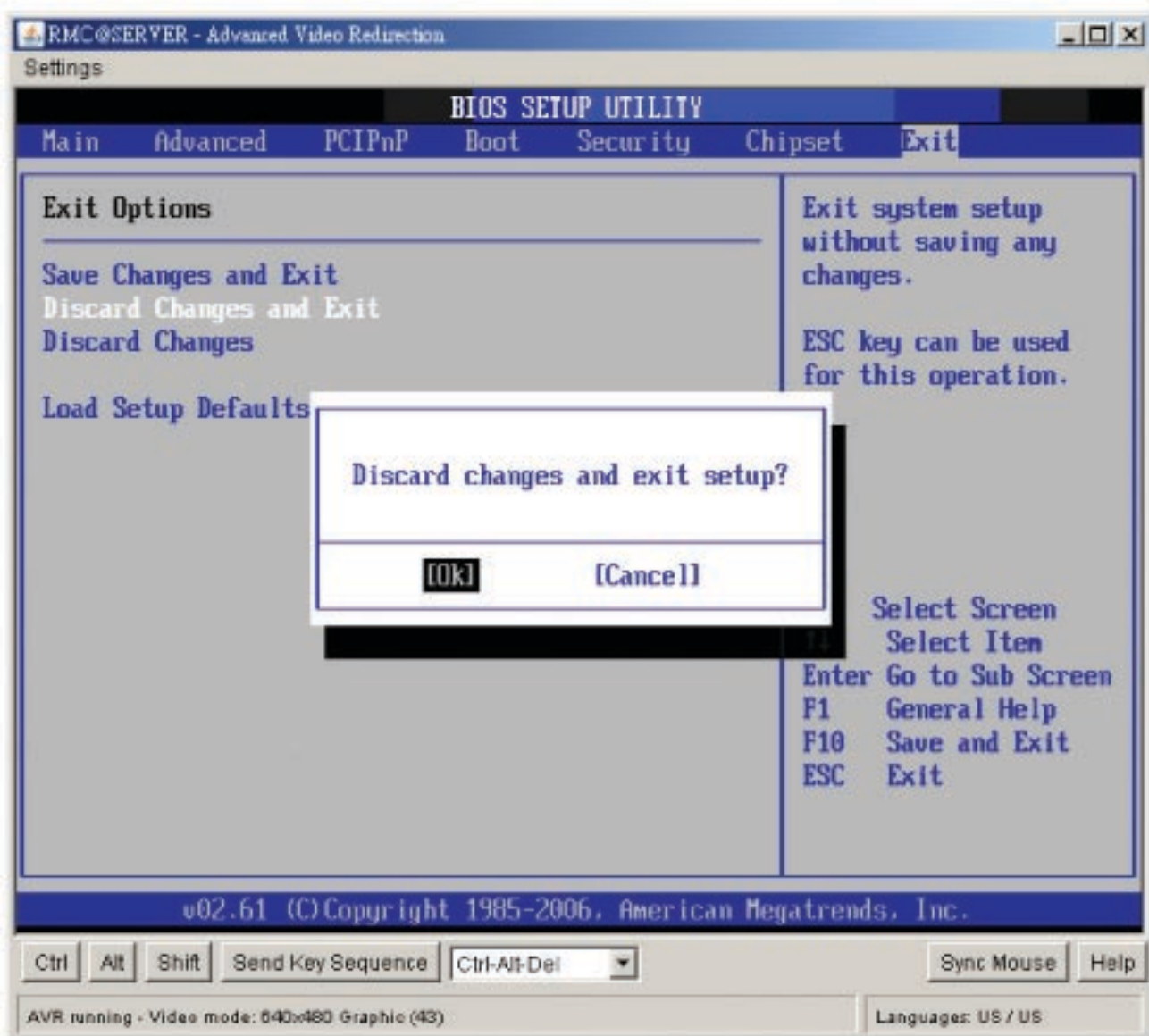

2.9.3 Discard Changes

Select Discard Changes from the Exit menu and press <Enter>.

Discard Changes ?

[Ok] [Cancel]

appears in the window. Select *Ok* to discard changes.

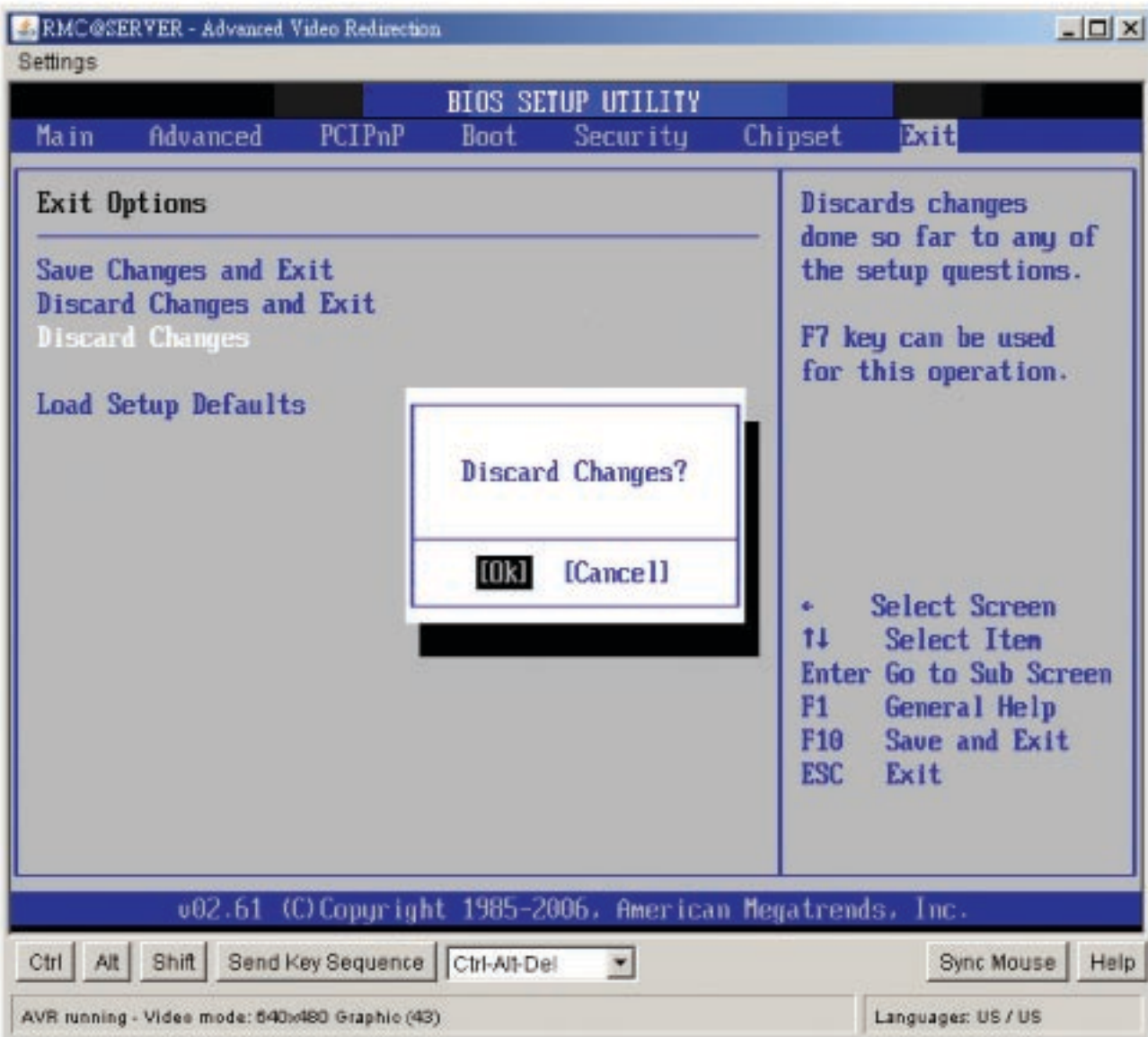

2.9.4 Load Setup Default

Automatically sets all Setup options to a complete set of default settings when you select this option. The Optimal settings are designed for maximum system performance, but may not work best for all computer applications. In particular, do not use the Optimal Setup options if your computer is experiencing system configuration problems. Select Load Setup Defaults from the Exit menu and press <Enter>. Select *Ok* to load optimal defaults.

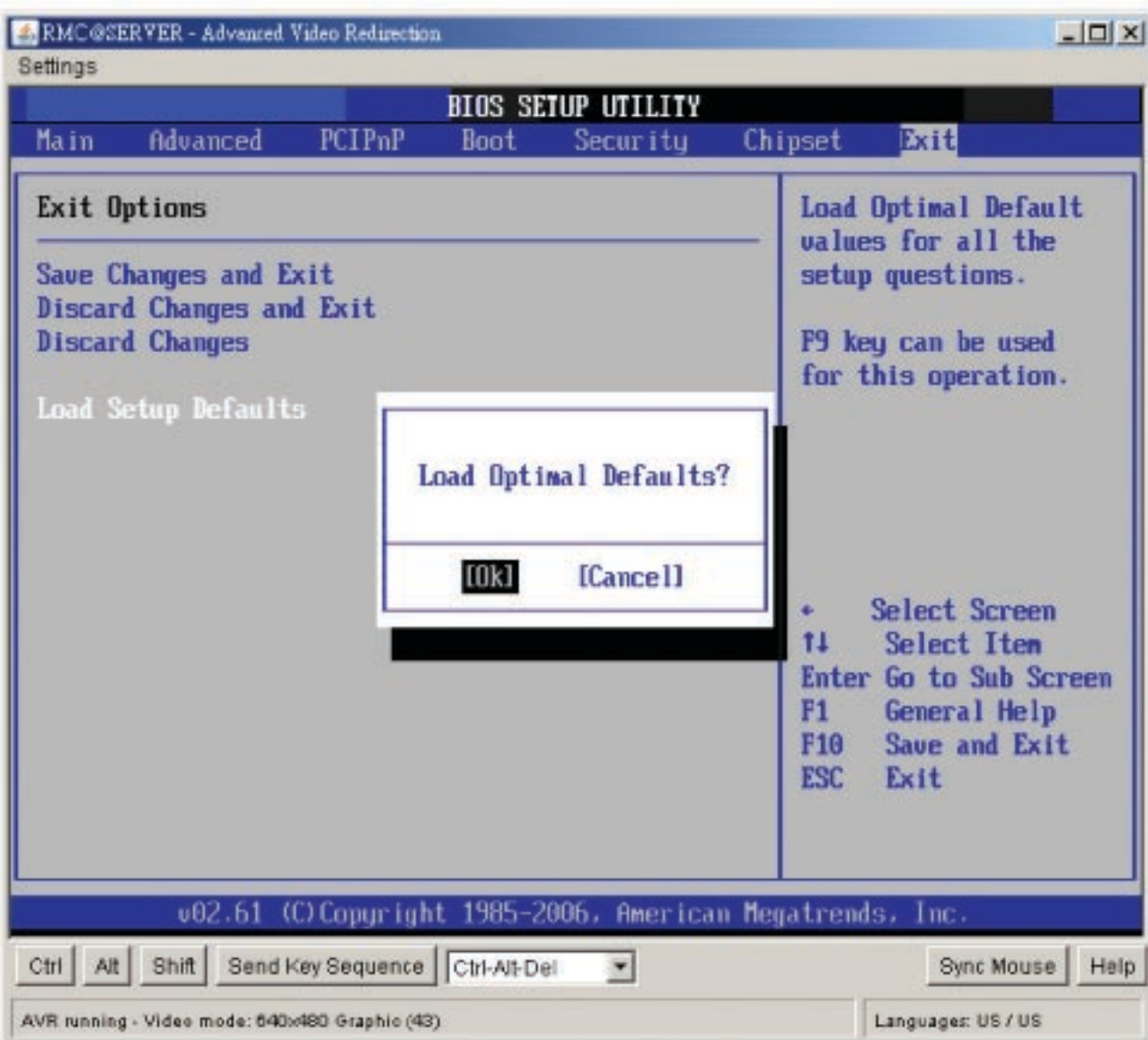

Intel® GM45 socket P Core™ 2 Duo / Core™ Duo / Core™ 2 Solo /Core™ Solo mobile CPU Mini-ITX Motherboard

Startup Manual

Packing List

Before you begin installing your single board, please make sure that the following parts have been shipped.

- 1 x Intel GM45 Mini-ITX Motherboard
- 1 x CD-ROM contains the followings:
 - User's Manual in PDF file
 - Drivers
- 1 x COM cable
- 2 x SATA cable
- 1 x Dual SATA Power Cable
- 1 x I/O Shield
- 1 x Startup Manual



Disclaimer and Notice



The manufacturer reserves the right to make changes, without notice, to any product, including circuits and/or software described or contained in this manual in order to improve design and/or performance. The manufacturer assumes no responsibility or liability for the use of the described product(s), conveys no license or title under any patent, copyright, or masks work rights to these products, and makes no representations or warranties that these products are free from patent, copyright, or mask work right infringement, unless otherwise specified. For the detail product information, please refer to user's manual.

I/O	
MIO	4 x SATA, 8 x USB, 5 x RS-232, 1 x K/B, 1 x Mouse (COM1~2 with power output)
USB	8 x USB 2.0 ports
DIO	8-bit General Purpose I/O for DI and DO
Display	
Chipset	Intel Graphics Media Accelerator 4500MHD
Display Memory	Intel DVMT 5.0 supports 384 MB video memory
Resolution	2048 x 1536 @ 32 bpp(@ 60Hz)
Dual Display	CRT + LVDS, or CRT + DVI-D
LVDS	Dual-channel 24-bit LVDS
DVI	T1 SN75DP139 DisplayPort to TMDS transmitter
HDMI	Chrontel CH7318C DVI transmitter up to 165M pixels/second
Audio	
Audio Codec	Realtek ALC888 Audio Codec 5.1+2 CH. with two independent audio stream
Audio Interface	Mic in, Line in, Line out
Audio Amplifier	TPA3005D2 Stereo 5Watt per channel
Ethernet	
LAN1	Intel 82567LM Gigabit Ethernet Controller
LAN2	Intel 82574L PCI-E Gigabit Ethernet Controller (optional)

Jumpers

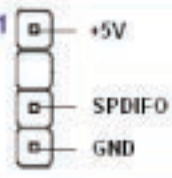
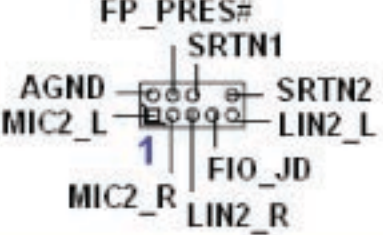
Label	Function	Note
CLRTC1	Clear CMOS	<p>Normal *  1</p> <p>Clear CMOS  1</p>
SPDIF_OUT1		
AAFP1	Front Panel Audio Connector	

Connectors

Label	Function	Note
JAMP1	Amplifier Connector	
Panel1	System Panel Connector	
JBKL1	LCD Inverter Connector	
JLVDS1	LVDS Connector	
COMPWR1	COM1, COM2 RI/+5V/+12V	
COMPWR2	Selection	
COM23	COM Connector	
COM45		